

# Toyota Land Cruiser 250

## HOOD STRUT KIT

### Installation Manual







Model year: Toyota Land Cruiser 250 2024-Present

Part No.: 2A.ST.5720.1

Compatibility: all types

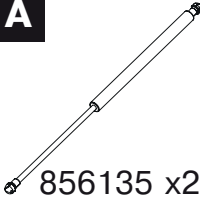
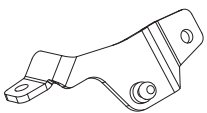
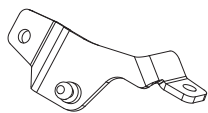
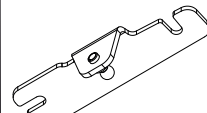
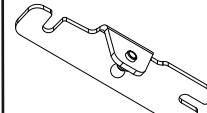
Weight:  1.8 kg

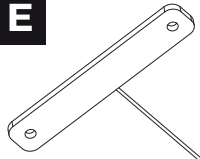
Installation time:  30 min

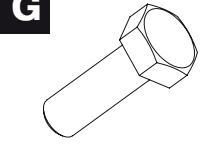
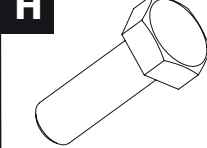
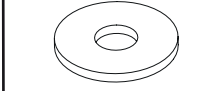
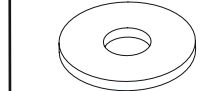
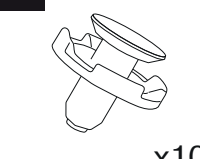
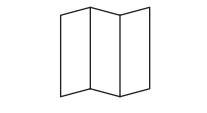
<b>A</b>  856135 x2	<b>B(R)</b>  x1	<b>B(L)</b>  x1	<b>C(R)</b>  x1	<b>C(L)</b>  x1	<b>D</b>  M6 x2
<b>E</b>  x2	<b>F</b>  x1	<b>G</b>  M6x25 x2	<b>H</b>  M8x25 x4	<b>I</b>  Ø6 x2	<b>J</b>  Ø8 x4
<b>K</b>  x10	 Installation Manual				

## Required Tools

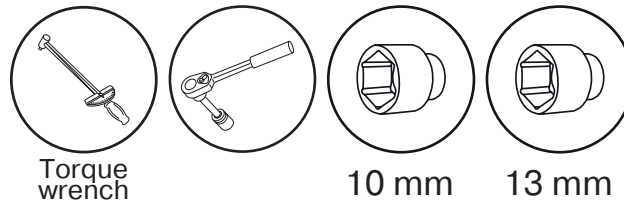

Before installation of gas struts, open the hood and check that there is no additional equipment installed in engine bay which can block installation.

**1**

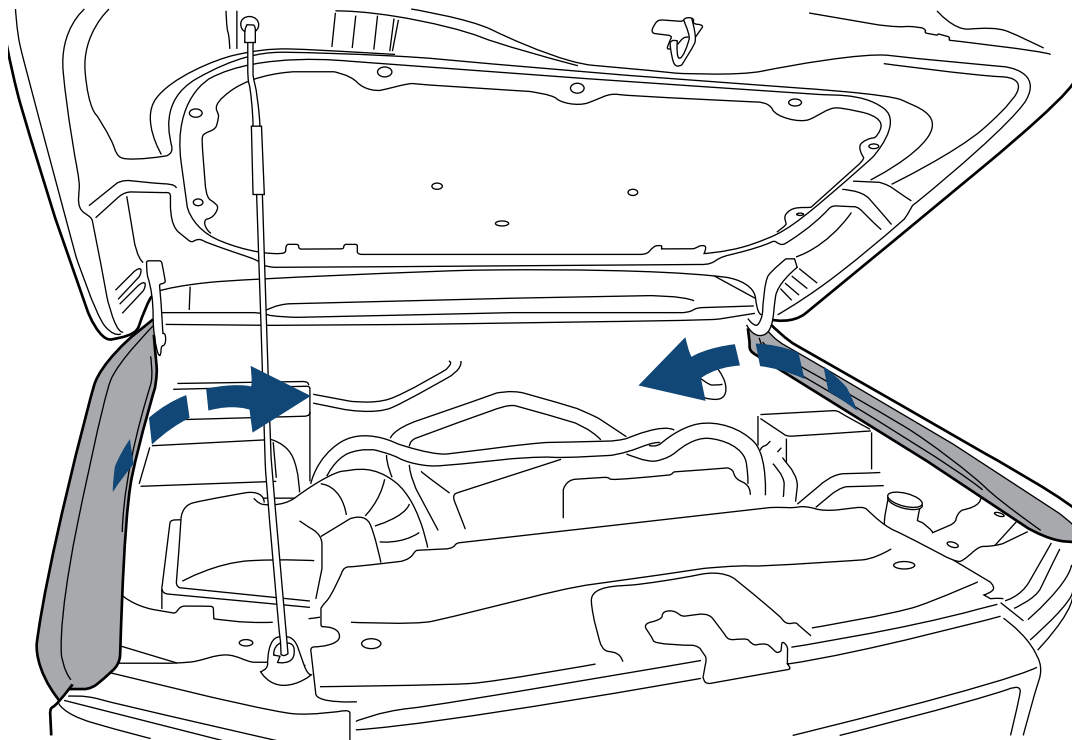

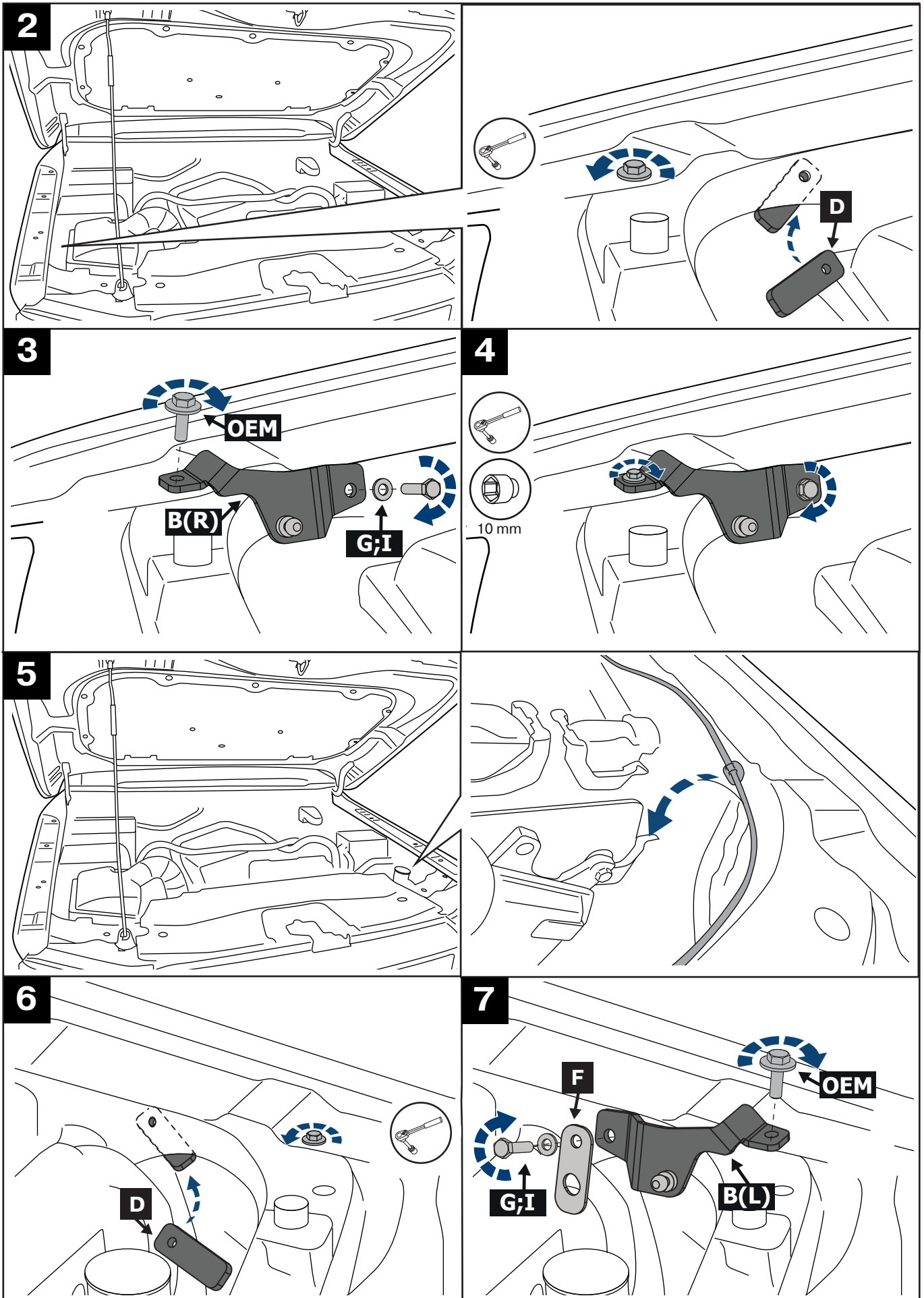

TOYOTA LAND CRUISER 250

HOOD STRUT KIT

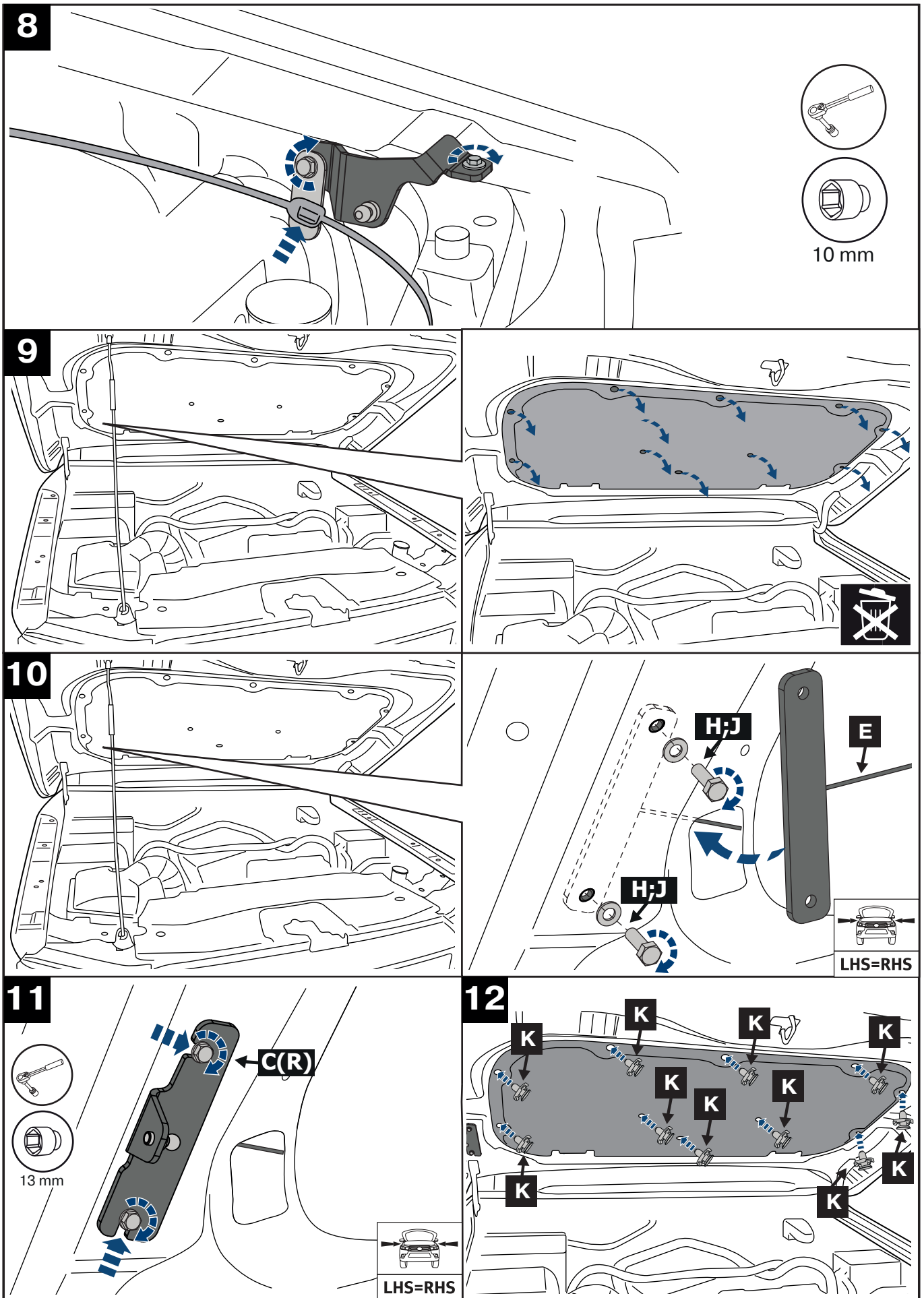

TOYOTA LAND CRUISER 250

HOOD STRUT KIT

13

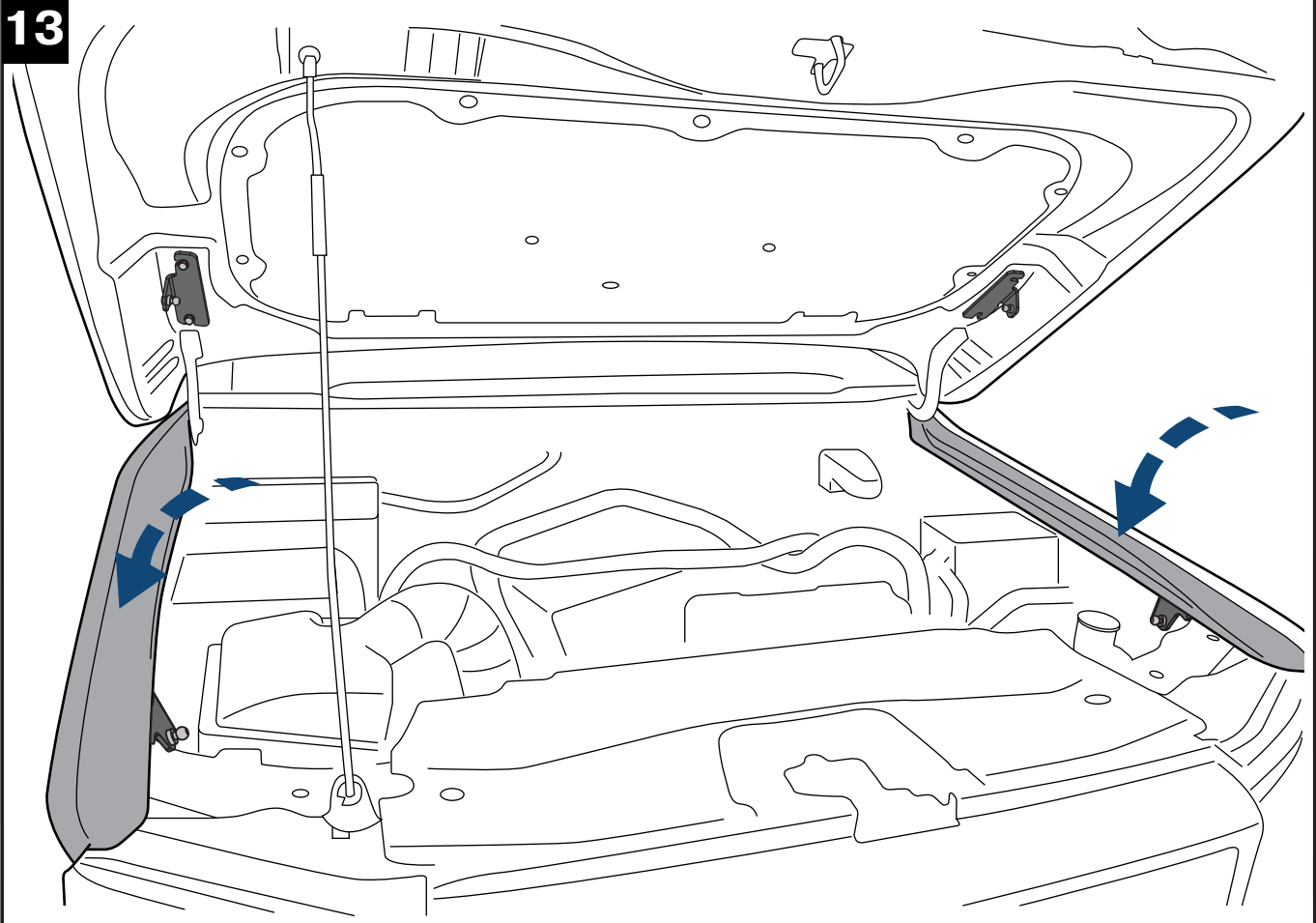

14

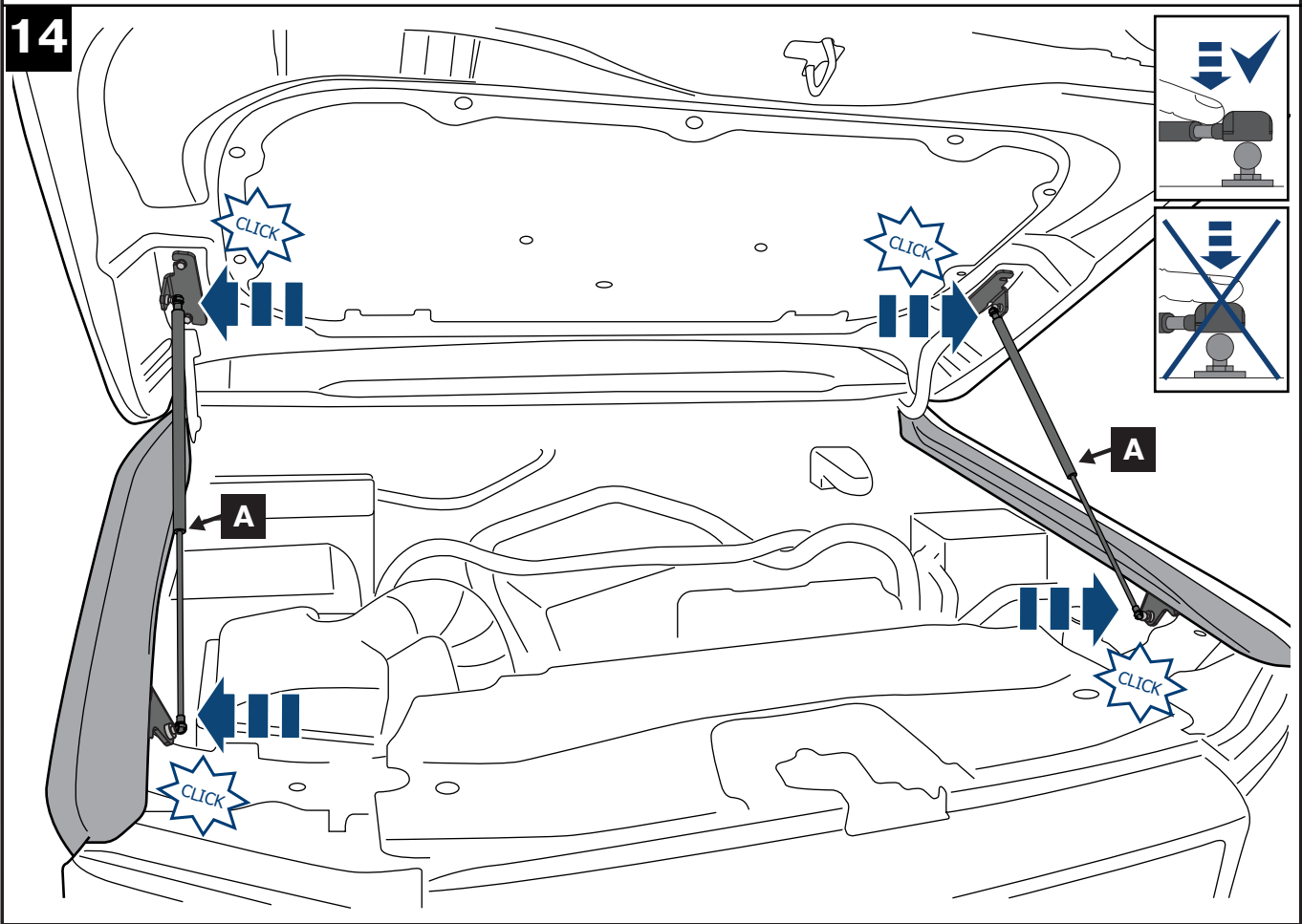

TOYOTA LAND CRUISER 250

HOOD STRUT KIT

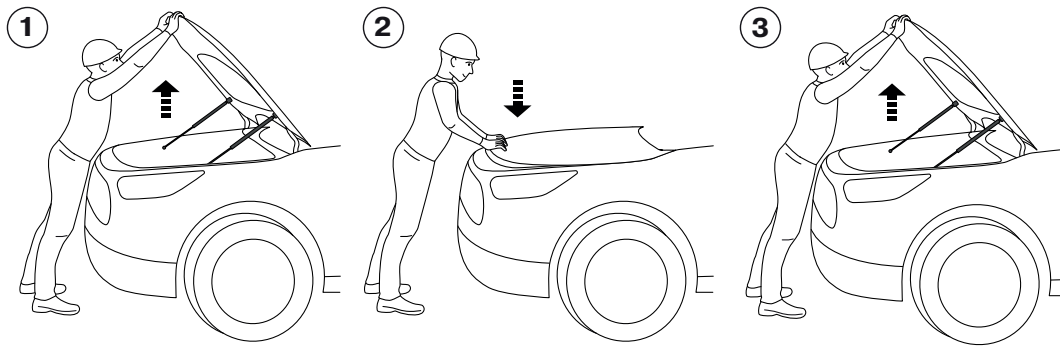

After installation, open and close smoothly the hood a few times to break in the struts for consistent operation.

**Attention!**

Make sure that the gas struts and brackets don't touch the car elements. Avoid slamming the hood lid.



Attention!  
If it's needed to remove installed gas strut, disassemble how shown on the picture.  
Operate with the hood being totally open.

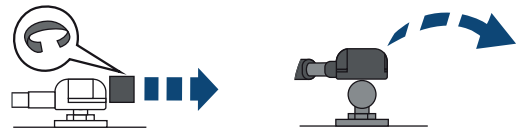

Check installation manual



After installation, check the correct operation of all elements.