

## TRANSMISSION SKID PLATE

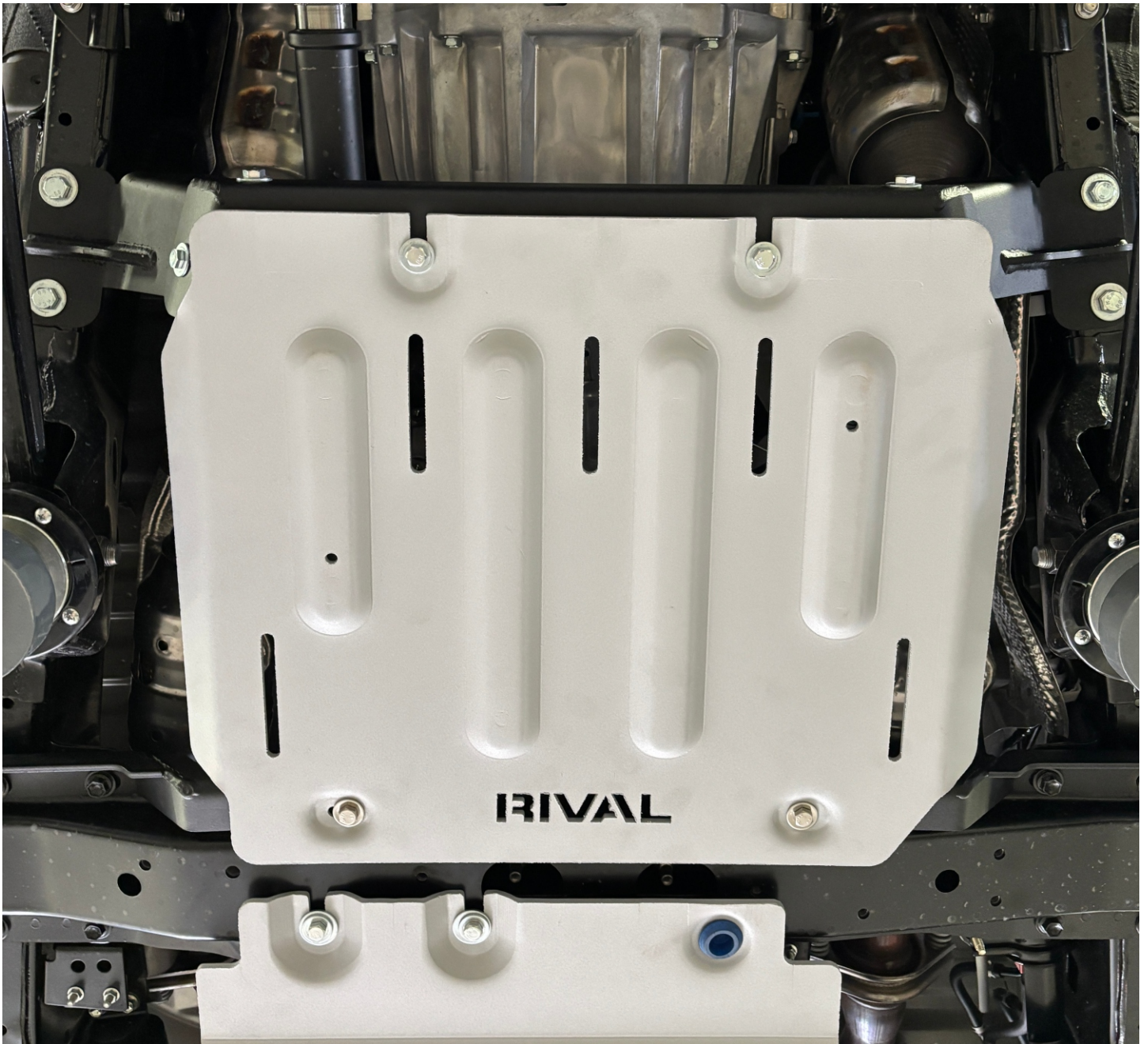

Material: aluminum / steel

Part number: 2333.9577.1.6

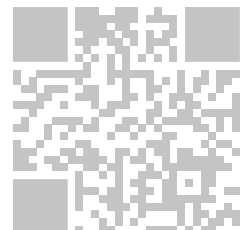

UP-TO-DATE MANUAL

# READ BEFORE INSTALLATION

## CAUTION!

To reduce the risk of serious injury or damage to property: before you start installing and using this product, read the full instructions, pay special attention to the conditions of safe use and recommendations for installation! When installing or maintaining this product, it is necessary to use protective goggles. Check the integrity of the installed components and torque all hardware every 250 miles (400 kms). Discontinue use if there is any damage to the structure or fasteners!

## NOTICE

Skid plates are supplemental protection. We cannot guarantee protection against all possible damage from impacts. When driving, be careful of objects and terrain that may damage sensitive parts of the vehicle.

## SAFETY NOTICE

- The RIVAL skid plate is designed to complement the use and design of the specified vehicle under conditions underlined by the vehicle manufacturer.
- While driving the vehicle at any speed, collision with another vehicle, animal or object must always be avoided.
- Following any collision with another vehicle, animal or object, the RIVAL skid plate and the vehicle must be inspected by a specialized or suitably qualified vehicle technician for possible damage to the components and assemblies in order to confirm suitability for further use of the vehicle.
- It is strongly recommended that you do not operate a vehicle with a damaged skid plate or its components. In the case of damage, please contact the nearest RIVAL dealer. A damaged vehicle or skid plate is extremely dangerous and should be avoided at all cost.
- If applicable, we recommend using a funnel when changing the oil to prevent spills and ensure a clean process.

## INSTALLATION NOTICE

- The RIVAL skid plate must be mounted to the vehicle according to this installation manual.
- Personal safety during the installation process must be adhered to at all times.
- Do not install this skid plate on vehicle models other than those listed in this manual.
- We recommend using blue threadlocker on all hardware.
- Estimated time for installation: 1 hour.

### Required tools

Basic tool kit  
Torque wrench

### Torque setting

M8 - 24 Nm (17.7 lb/ft)  
M10 - 30 H·m (22.1 lb/ft)

# VEHICLE COMPATIBILITY

---



Toyota Land Cruiser 76 4.0, 4.5D, 2.8D; MT, AT; 4WD; (2023-present)



Toyota Land Cruiser 79 4.0, 4.5D, 2.8D; MT, AT; 4WD; Double Cab, Single Cab (2023-present)

# PARTS LISTING

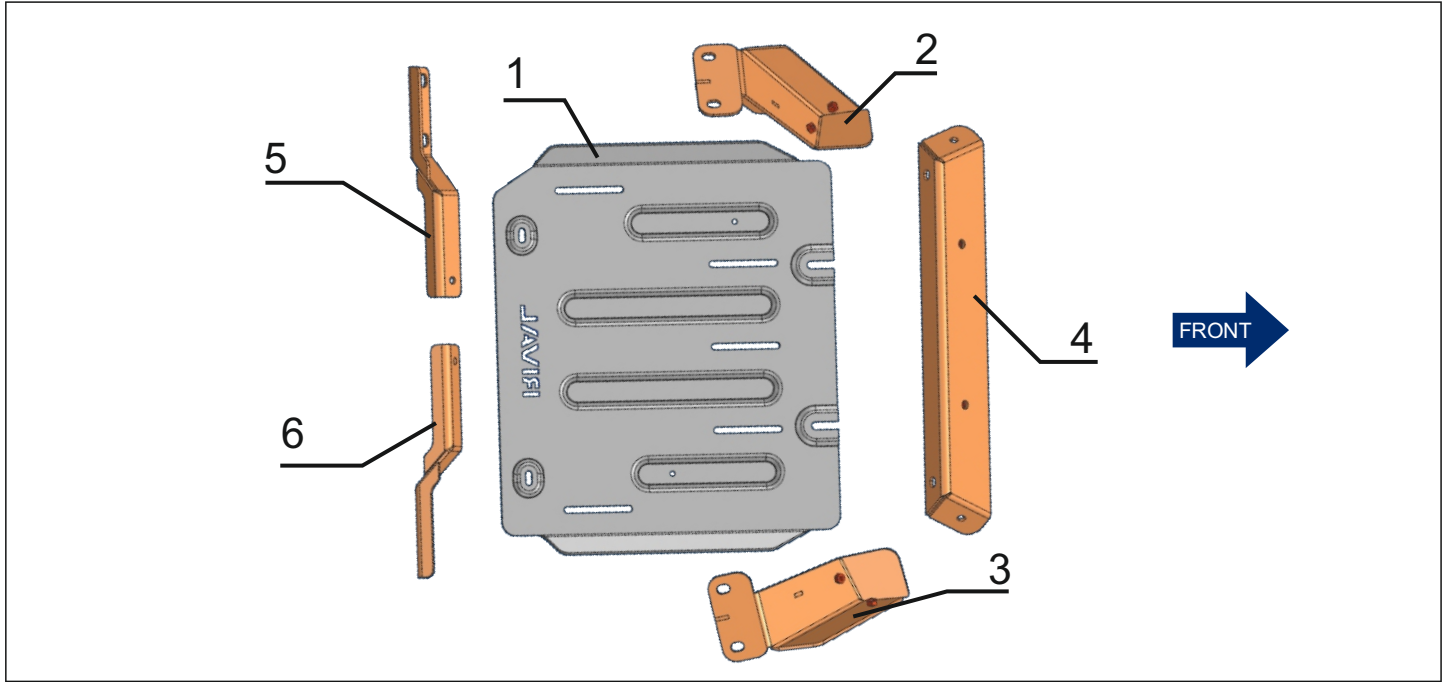

1	Transmission skid plate
2	Left front bracket
3	Right front bracket
4	Front bracket
5	Left rear bracket

6	Right rear bracket
---	--------------------

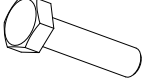
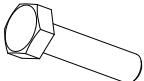
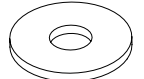
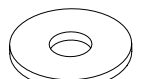
A		Bolt M10x1.25x35	6
B		Bolt M8x1.25x25	6
C		Washer M10	6
D		Washer M8	6

# INSTALLATION PROCEDURE

Fig. 1

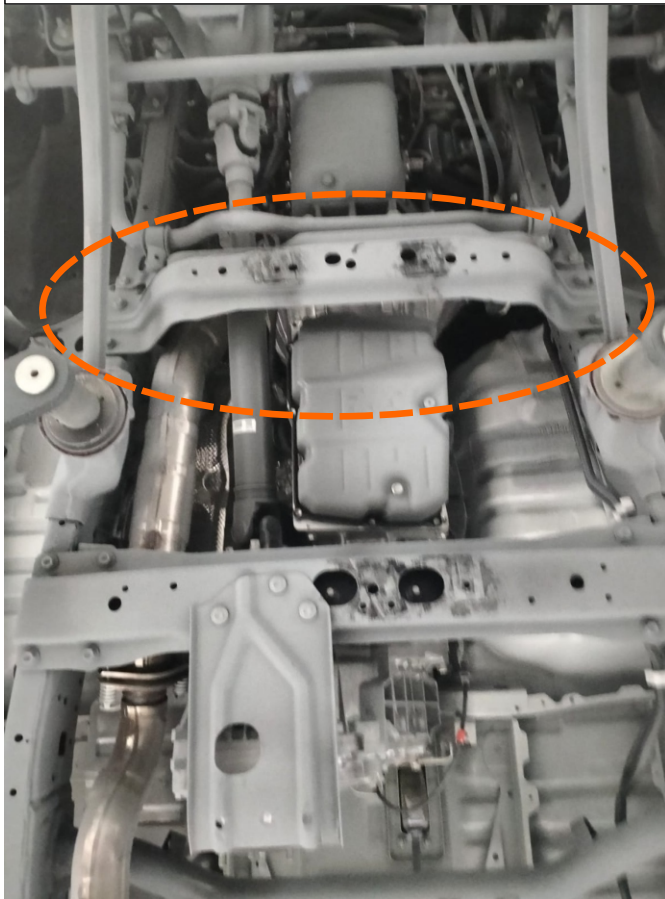

1. If your vehicle is equipped with a factory crossmember as shown in fig. 1, skip steps 3-7

Fig. 2

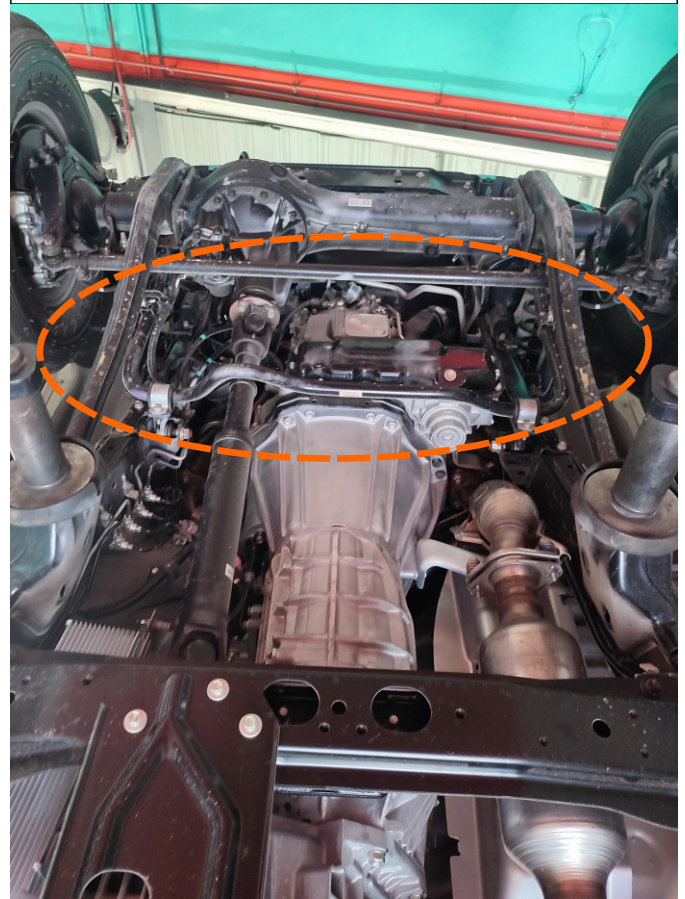

2. If your vehicle is not equipped with a factory crossmember as shown in fig. 2, skip steps 8-10

# INSTALLATION PROCEDURE

 \*If equipped, remove factory or any aftermarket skid plates that might interfere with installation.

Fig. 3

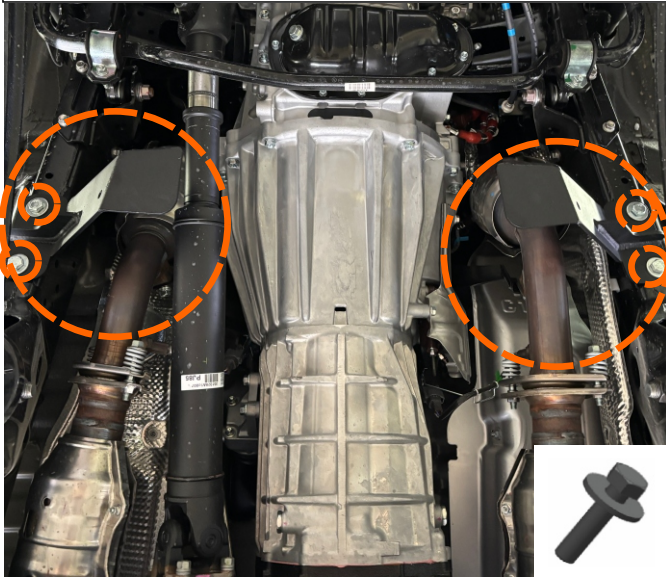

3. Install left and right front bracket (items 2,3) using bolts M10x235, washers M10 (items A,C) as shown in fig. 3.

**\*Do not tighten yet.**

Fig. 4

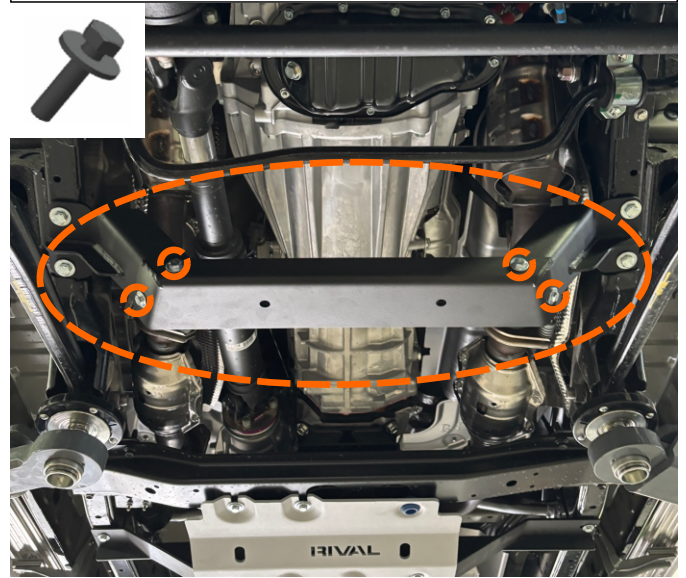

4. Install bracket (item 4) using bolts M8x25, washers M8 (items B,D) as shown in fig. 4.

**\*Do not tighten yet.**

Fig. 5

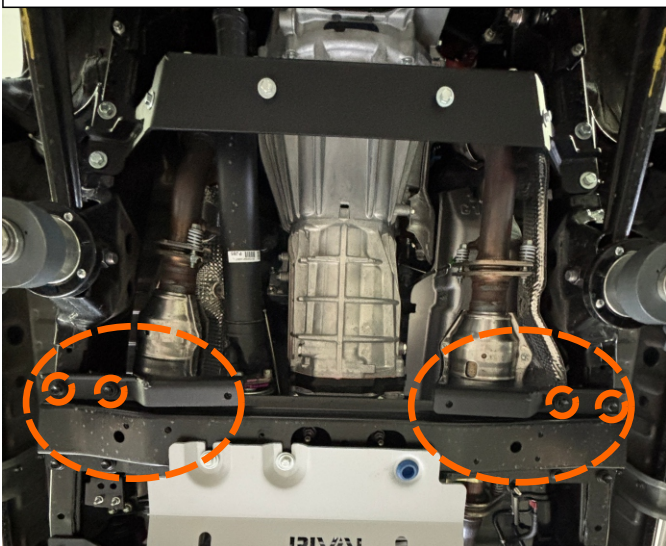

5. Install left and right rear bracket (items 5,6) using factory bolts as shown in fig. 5.

Fig. 6



6. Slightly install bolts M10x35, washers M10 (items A,C) as shown in fig.6.

# INSTALLATION PROCEDURE

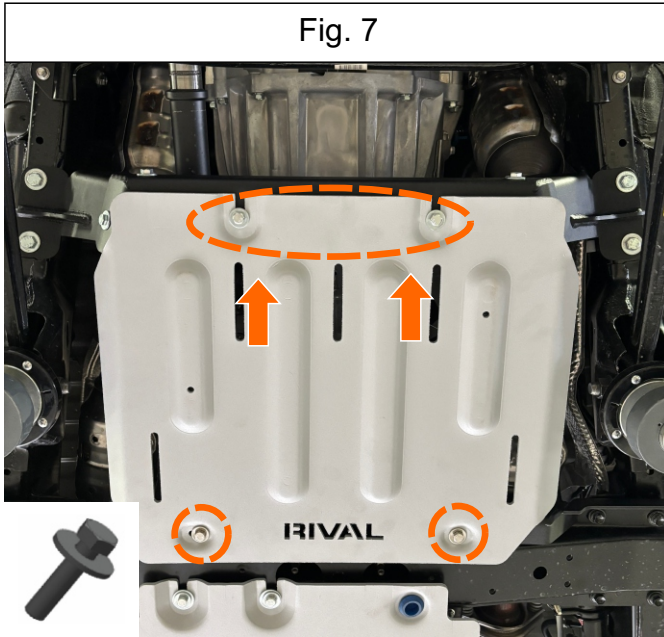

7. Slide the front transmission skid plate (item 1) and fix using bolts M8x25, washers M8 (items B,D) as shown in fig.7.

**\*Once all bolts are inserted, check skid plate alignment and tighten all previously installed hardware.**



**Before operating a vehicle fitted with RIVAL skid plates:**

- **Make sure all fittings are properly torqued.**
- **Ensure the integrity of the structure and its components.**

# INSTALLATION PROCEDURE

 \*If equipped, remove factory or any aftermarket skid plates that might interfere with installation.

Fig. 8

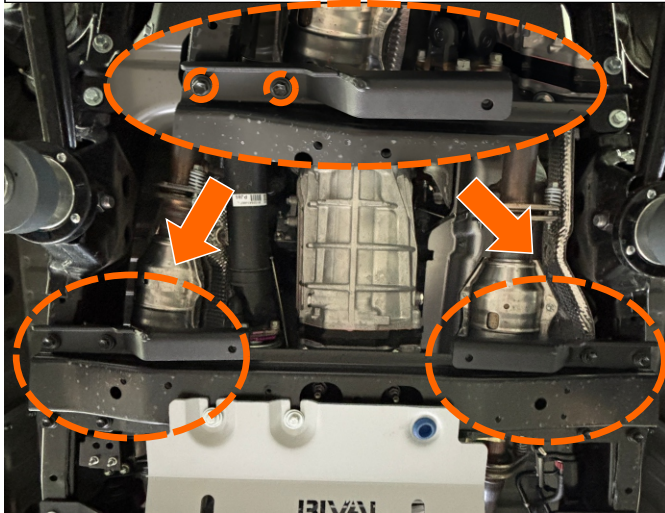

8. Install left and right rear bracket (items 5,6) using factory bolts as shown in fig. 8.

Fig. 9

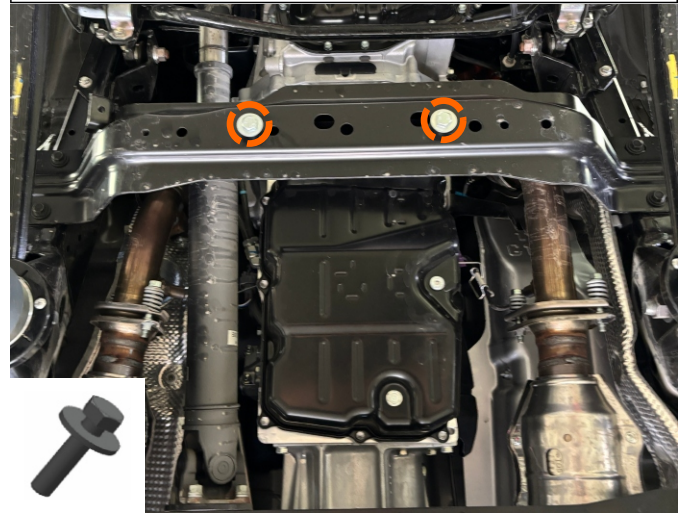

9. Slightly install bolts M10x35, washers M10 (items A,C) as shown in fig. 9.

Fig. 10

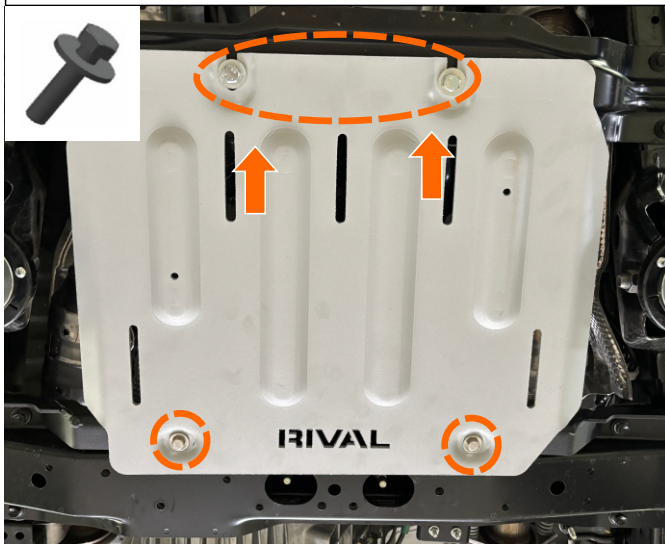

10. Slide the front transmission skid plate (item 1) and fix using bolts M8x25, washers M8 (items B,D) as shown in fig. 10.

**\*Once all bolts are inserted, check skid plate alignment and tighten all previously installed hardware.**

 **Before operating a vehicle fitted with RIVAL skid plates:**

- **Make sure all fittings are properly torqued.**
- **Ensure the integrity of the structure and its components.**