

# INSTALLATION MANUAL

PRODUCT: ENGINE SKID PLATE

APPLICATION: FORD RANGER (2022-Present)  
FORD RANGER RAPTOR (2022-Present)  
FORD EVEREST (2022-Present)  
VOLKSWAGEN AMAROK (2023-Present)

PART NO: 2111.1885.1.3  
2333.1885.1  
2333.1885.1.6

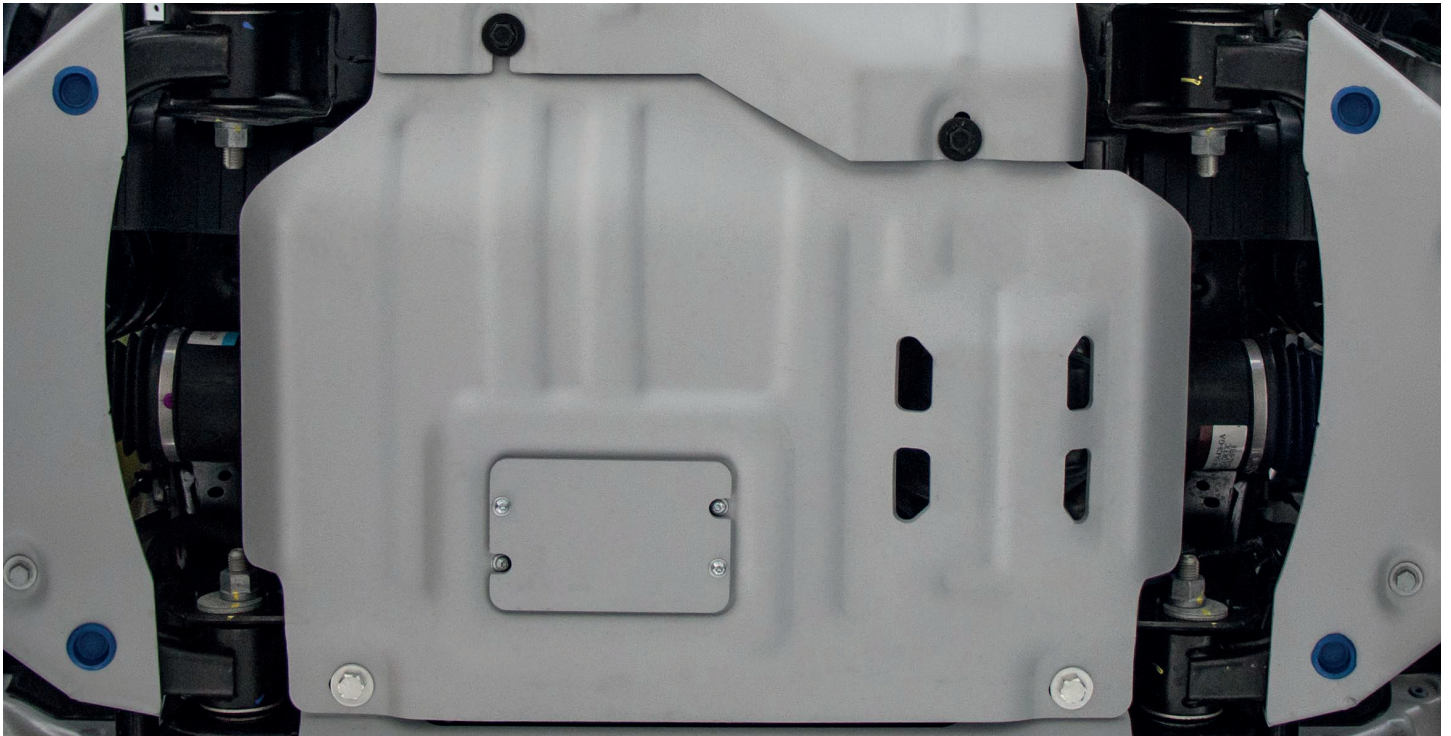

## CAUTION!

To reduce the risk of serious injury or damage to property: Before you start installing and using this product, read the full instructions, pay special attention to the conditions of safe use and recommendations for installation! When installing or maintaining this product, it is necessary to use protective goggles. Check the integrity of the structure and the moment the fastening is tightened every 250 miles (400 kms) of mileage. Do not use this product if there is damage to the structure or fasteners!

## NOTICE

Skid plate is an additional protection, but it can not guarantee to protect against all possible damage in collisions. When driving, be careful of objects and terrain that may damage sensitive parts of the vehicle.

# ENGINE SKID PLATE



Part number 2111.1885.1.3  
2333.1885.1  
2333.1885.1.6

Suited to vehicle: Ford Ranger\* 2.0D Bi-Turbo, 3.0D; AT; 4WD (2022-Present)  
Ford Ranger Raptor 3.0; AT; 4WD (2022-Present)  
Ford Everest 2.0D Bi-Turbo; AT; 4WD (2022-Present)  
Volkswagen Amarok 2.0D, 3.0D; AT; 4WD (2023-Present)

Material: Steel / Aluminum

\*Applicable to Double Cab



## SAFETY NOTICE

- \* The RIVAL engine skid plate is designed to complement the use and design of the specified vehicle under conditions specified by the vehicle manufacturer.
- \* While driving the vehicle at any speed, collision with any other vehicle, animal or object must always be avoided.
- \* Following any collision with any other vehicle, animal or object, the RIVAL engine skid plate and the vehicle must be inspected by a specialized or suitably qualified vehicle repairer for possible damage to the components and assemblies in order to confirm suitability for further use of the vehicle.
- \* It is strongly recommended that you do not operate a vehicle with a damaged engine skid plate or its components. In the case of damage, please contact the nearest RIVAL dealer. Vehicle, or where the skid plate has been damaged, is extremely dangerous and must be avoided at all cost.

## INSTALLATION NOTICE

- \* The RIVAL engine skid plate must be mounted and affixed to the vehicle according to this installation manual.
- \* Personal safety during the installation process must be adhered to at all times.
- \* Do not install this skid plate on vehicle models other than those allowed in this manual.
- \* Estimated time for installation: 1 hour.

## REQUIRED TOOLS

- \* Basic tool kit
- \* Torque wrench

## TORQUE SETTING

- \* M10 - 47 H·m (34.7 lb/ft)

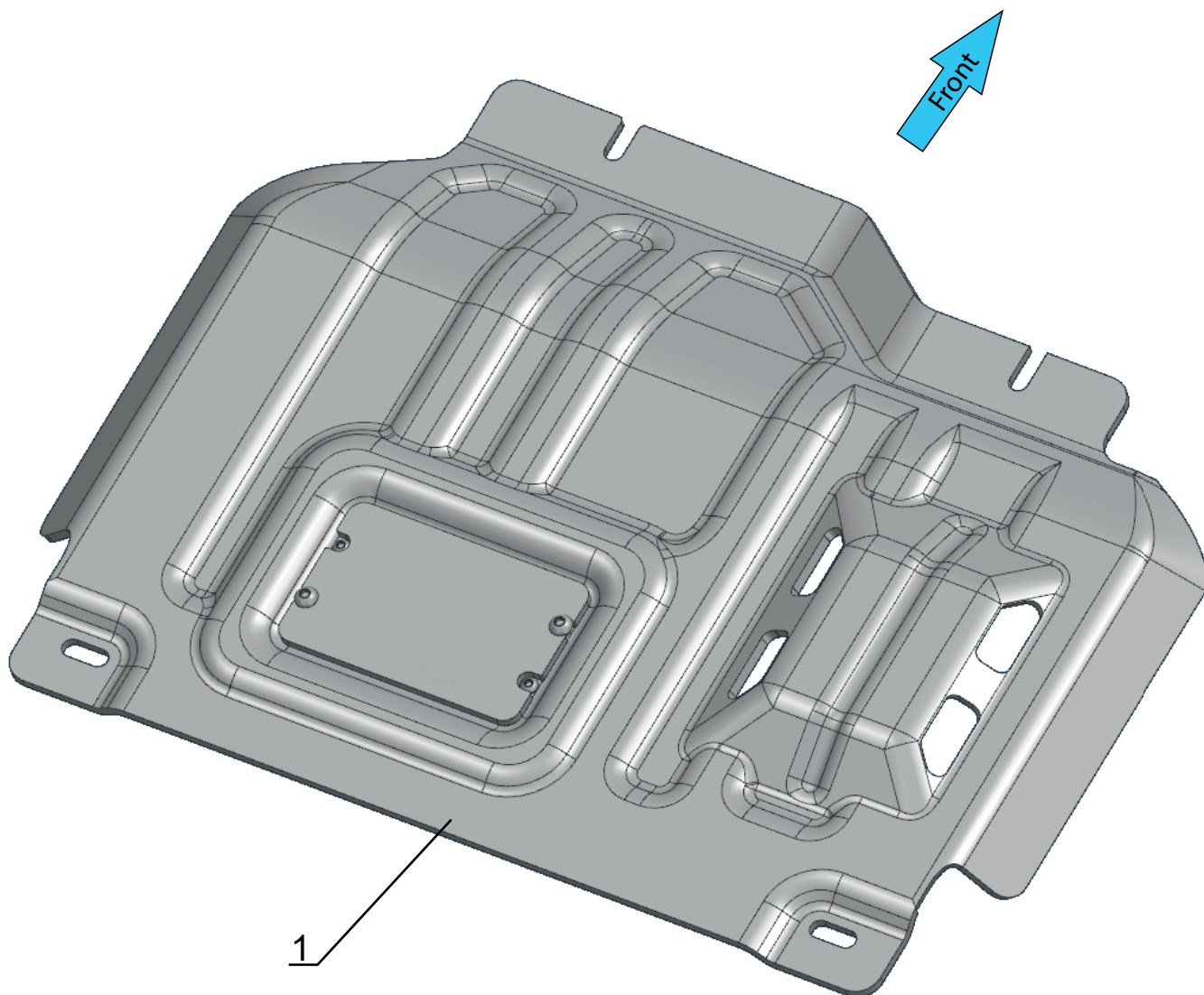

1. Engine skid plate.....Qty 1

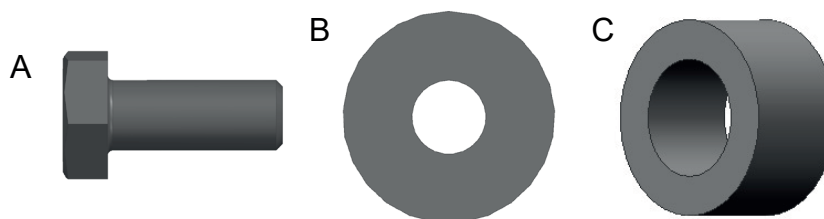

A. Bolt M10x30.....Qty 4  
 B. Washer 10.....Qty 4  
 C. Spacer.....Qty 2

# INSTALLATION PROCEDURE



\*If equipped, remove the factory skid plate or any other aftermarket skid plate.

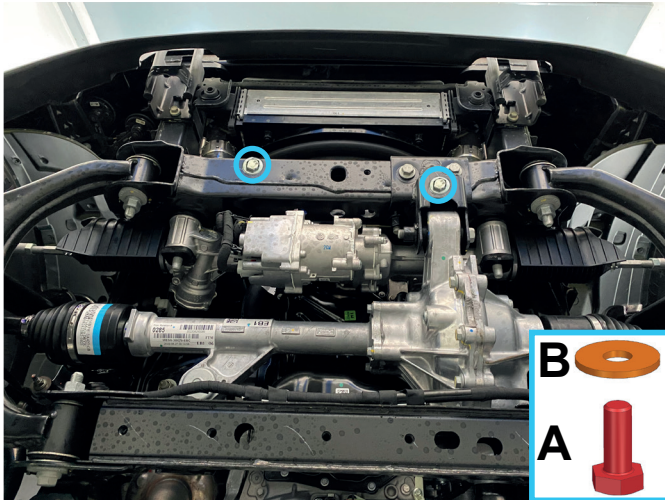

Fig. 1

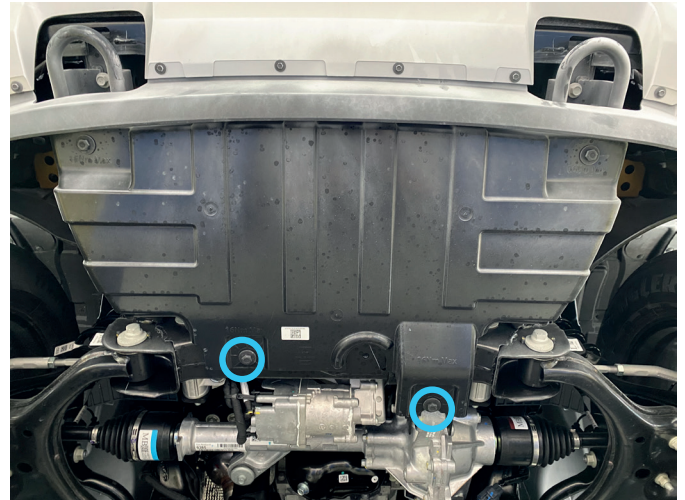

Fig. 2

1. Attach bolts M10x30 (item A) and washers 10 (item B), as shown in fig.1.

**\*Do not tighten yet.**

\*\*If the vehicle has radiator skid plate, loosen the rear bolts of radiator skid plate or bolts of RIVAL radiator skid plate 2111.1884.1.3 / 2333.1884.1 / 2333.1884.1.6 (fig.2).

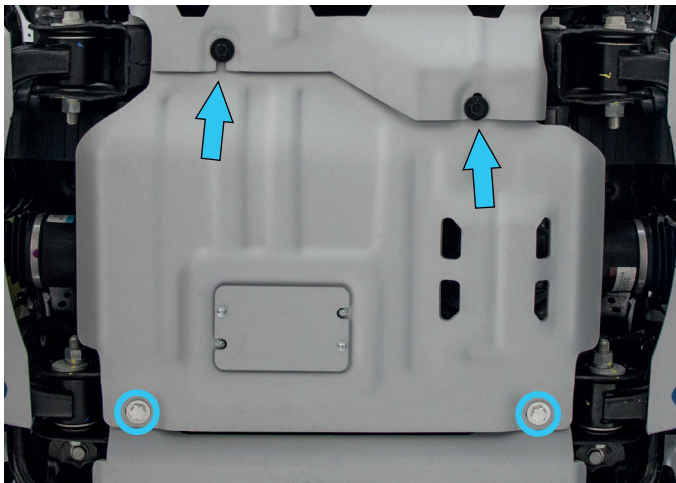

Fig. 3

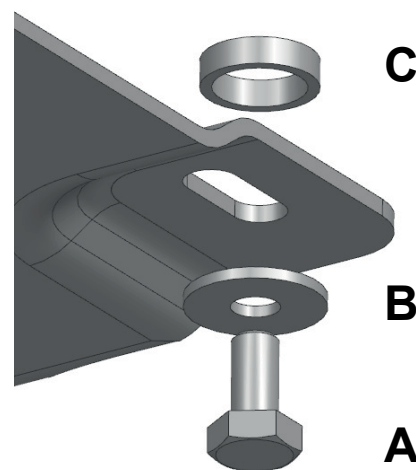

Fig. 4

2. Put the front part of skid plate (item 1) on installed bolts M10x30 and washers 10 from step 1. Fix the rear part of engine skid plate using bolts M10x30 (item A), washers 10 (item B) and spacers (item C) as shown in fig.3.

**\*Tighten hardware after that.**

\*Do not use spacers (item C), in case if you plan to install RIVAL gearbox skid plate.

Before operating a vehicle fitted with RIVAL Skid Plate:

- make sure all fittings are tightened;
- ensure the integrity of the structure and its components.

# INSTALLATION MANUAL

PRODUCT: GEARBOX SKID PLATE

APPLICATION: FORD RANGER (2022-)  
FORD RANGER RAPTOR (2022-)  
FORD EVEREST (2022-)  
VOLKSWAGEN AMAROK (2023-)

PART NO: 2111.1886.2.3  
2333.1886.2  
2333.1886.2.6



## CAUTION!

To reduce the risk of serious injury or damage to property: Before you start installing and using this product, read the full instructions, pay special attention to the conditions of safe use and recommendations for installation! When installing or maintaining this product, it is necessary to use protective goggles. Check the integrity of the structure and the moment the fastening is tightened every 250 miles (400 kms) of mileage. Do not use this product if there is damage to the structure or fasteners!

## NOTICE

Skid plate is an additional protection, but it can not guarantee to protect against all possible damage in collisions. When driving, be careful of objects and terrain that may damage sensitive parts of the vehicle.

# GEARBOX SKID PLATE



Part number 2111.1886.2.3  
2333.1886.2  
2333.1886.2.6



Suited to vehicle: FORD RANGER\* 3.0D, 2.0D Bi-Turbo; AT; 4WD (2022-)  
FORD RANGER RAPTOR 3.0; AT; 4WD (2022-)  
FORD EVEREST 2.0D Bi-Turbo; AT; 4WD (2022-)  
VOLKSWAGEN AMAROK 2.0D, 3.0D; AT; 4WD (2023-)

Material: Steel / Aluminum



\*Applicable to Double Cab

## SAFETY NOTICE

- \* The RIVAL gearbox skid plate is designed to complement the use and design of the specified vehicle under conditions specified by the vehicle manufacturer.
- \* While driving the vehicle at any speed, collision with any other vehicle, animal or object must always be avoided.
- \* Following any collision with any other vehicle, animal or object, the RIVAL gearbox skid plate and the vehicle must be inspected by a specialized or suitably qualified vehicle repairer for possible damage to the components and assemblies in order to confirm suitability for further use of the vehicle.
- \* It is strongly recommended that you do not operate a vehicle with a damaged gearbox skid plate or its components. In the case of damage, please contact the nearest RIVAL dealer. Vehicle, or where the skid plate has been damaged, is extremely dangerous and must be avoided at all cost.

## INSTALLATION NOTICE

- \* The RIVAL gearbox skid plate must be mounted and affixed to the vehicle according to this installation manual.
- \* Personal safety during the installation process must be adhered to at all times.
- \* Do not install this skid plate on vehicle models other than those allowed in this manual.
- \* Estimated time for installation: 1 hour.

## REQUIRED TOOLS

- \* Basic tool kit
- \* Torque wrench

## TORQUE SETTING

- \* M10 - 47 H·m (34.7 lb/ft)

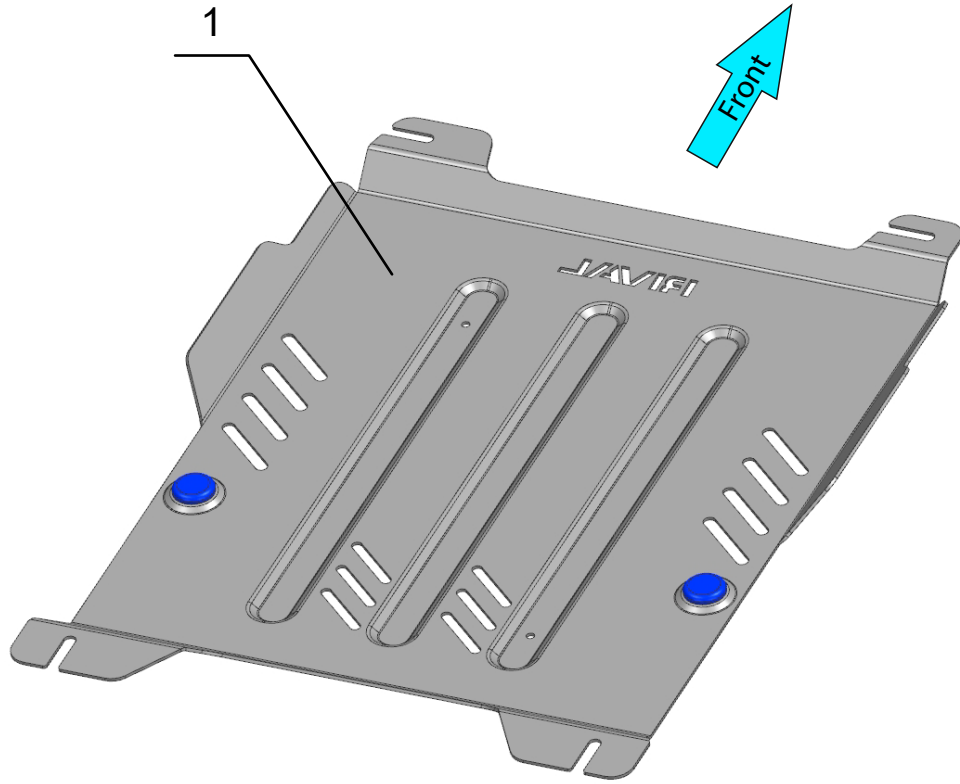

1. Gearbox skid plate.....Qty 1

# PARTS LISTING

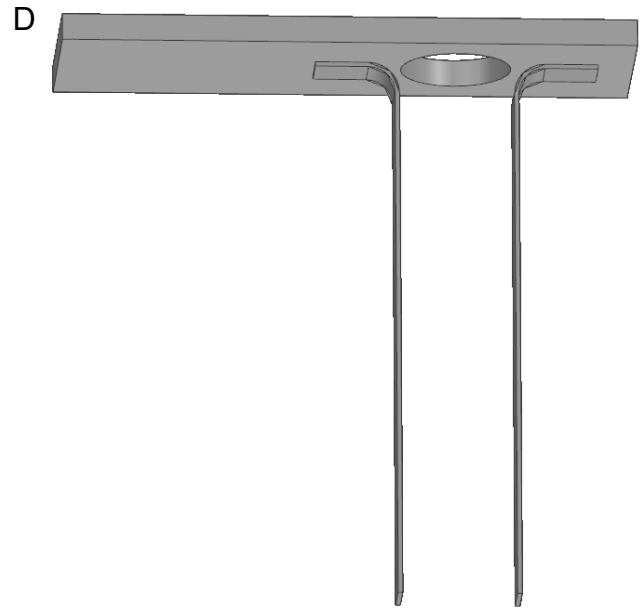
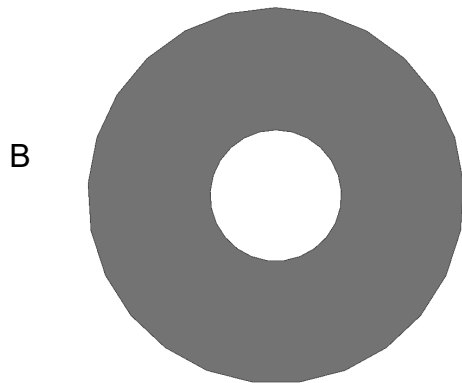
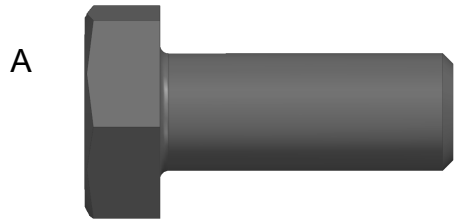

A. Bolt M10x30.....	Qty 6
B. Washer 10.....	Qty 6
C. Bracket.....	Qty 2
D. Insert nut M10.....	Qty 2

# INSTALLATION PROCEDURE



\*If equipped, remove the factory skid plate or any other aftermarket skid plate.  
\*Set aside hardware for re-use later on.

## For FORD EVEREST (2022-) FORD RANGER (2022-) VOLKSWAGEN AMAROK (2023-)

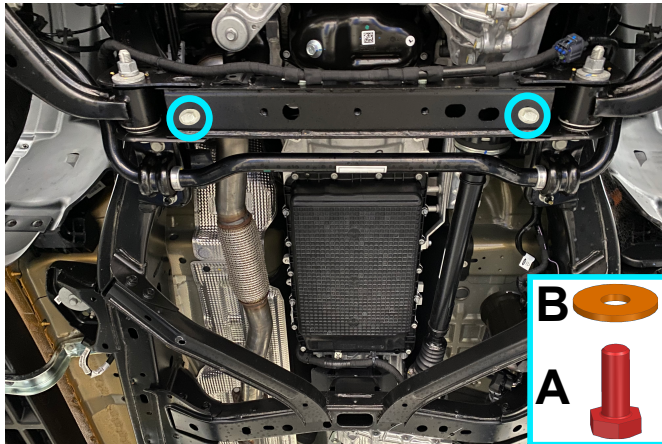

Fig. 1

1. Attach bolts M10x30 (item A) and washers 10 (item B), as shown in fig.1.

**\*Do not tighten yet.**

\*If engine skid plate or RIVAL engine skid plate is installed, loosen the rear bolts.

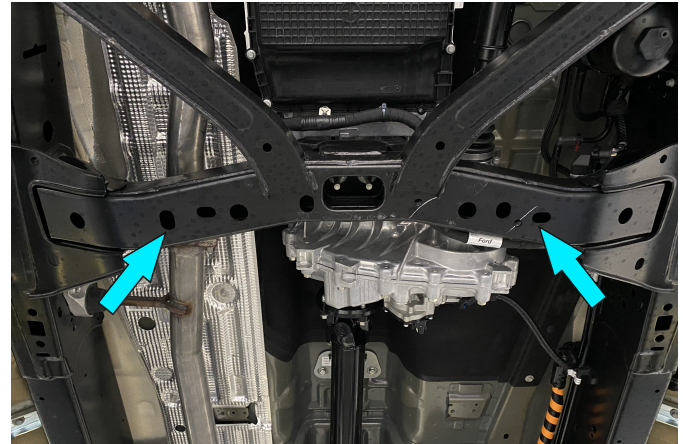

Fig. 2

2. Install the insert nut M10 (item D), as shown in fig.2.

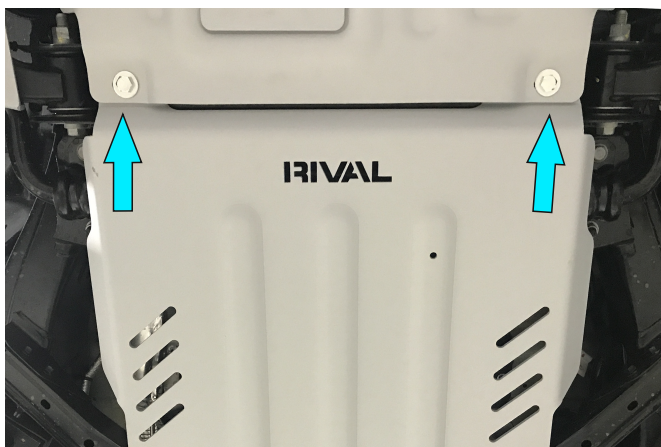

Fig. 3

3. Put the front part of gearbox skid plate (item 1) above engine skid plate or RIVAL engine skid plate on installed bolts (Fig.3).

**\*Do not tighten yet.**

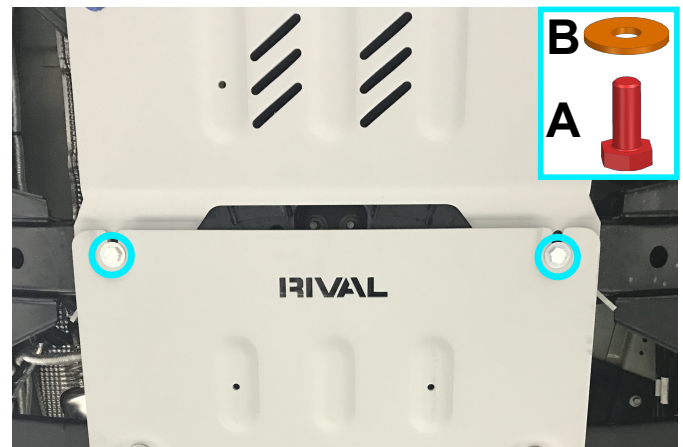

Fig. 4

4. Fix the rear part of gearbox skid plate (item 1) to insert nut M10 (item D) using bolts M10x30 (item A) and washers 10 (item B), as shown in fig.4.

**\*Tighten hardware after that.**

# INSTALLATION PROCEDURE



For FORD RANGER RAPTOR (2022-)

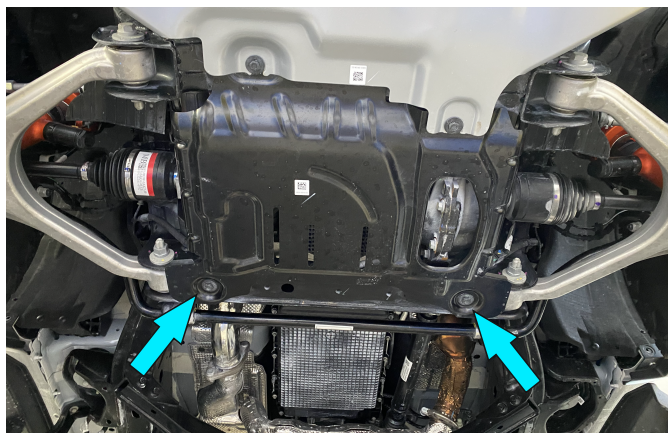

Fig. 1

1. Loosen the rear bolts of engine skid plate or bolts of RIVAL engine skid plate (fig.1).

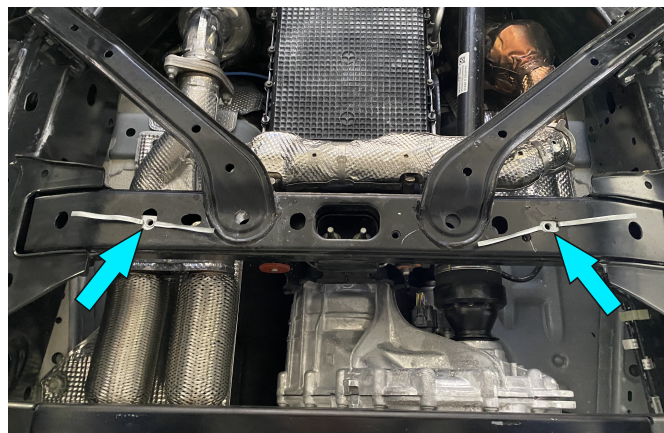

Fig. 2

2. Install the insert nut M10 (item D), as shown in fig.2.

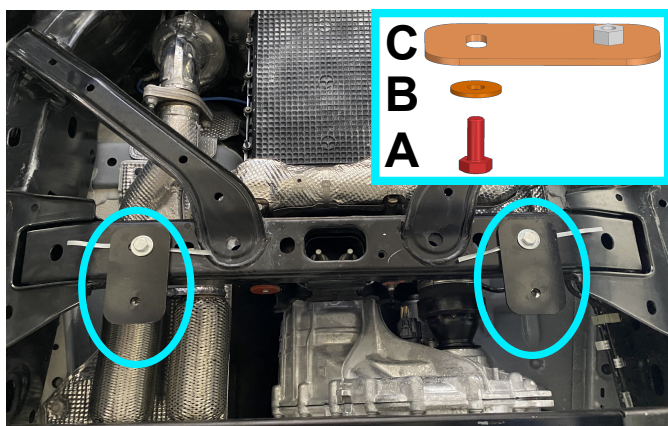

Fig. 3

3. Fix brackets (item C) to insert nut M10 (item D), using bolts M10x30 (item A) and washers 10 (item B), as shown in fig.3.

**\*Tighten hardware after that.**

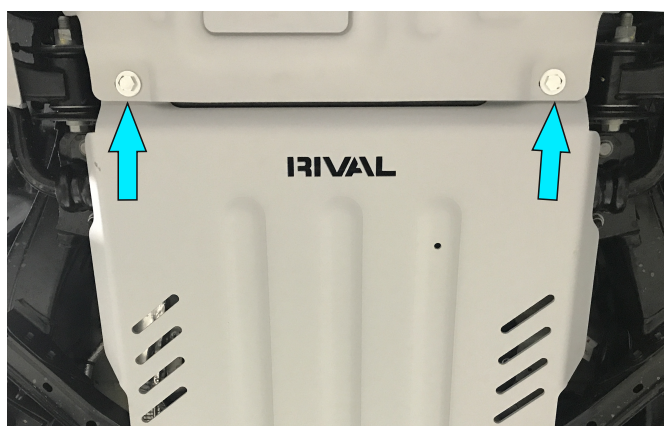

Fig. 4

4. Put the front part of gearbox skid plate (item 1) above engine skid plate or RIVAL engine skid plate on installed bolts (fig.4).

**\*Do not tighten yet.**

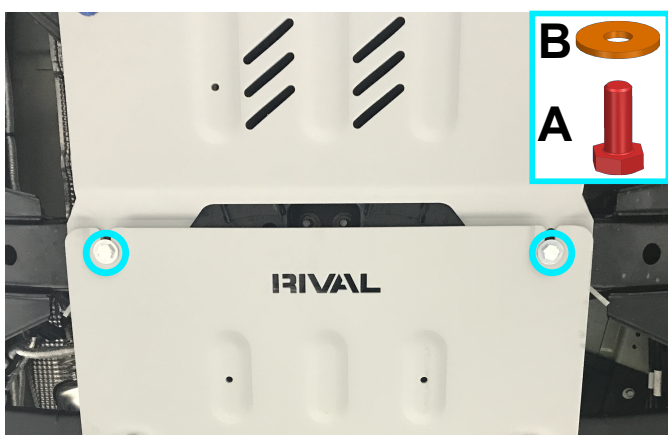

Fig. 5

5. Fix the rear part of gearbox skid plate (item 1) to brackets (item C), using bolts M10x30 (item A) and washers 10 (item B), as shown in fig.5.

**\*Tighten hardware after that.**

# INSTALLATION PROCEDURE



Before operating a vehicle fitted with RIVAL Skid Plate:

- make sure all fittings are tightened;
- ensure the integrity of the structure and its components.



# INSTALLATION MANUAL

PRODUCT: TRANSFER CASE SKID PLATE

APPLICATION: FORD RANGER (2022-)  
FORD RANGER RAPTOR (2022-)  
FORD EVEREST (2022-)  
VOLKSWAGEN AMAROK (2023-)

PART NO: 2111.1887.2.3  
2333.1887.2  
2333.1887.2.6

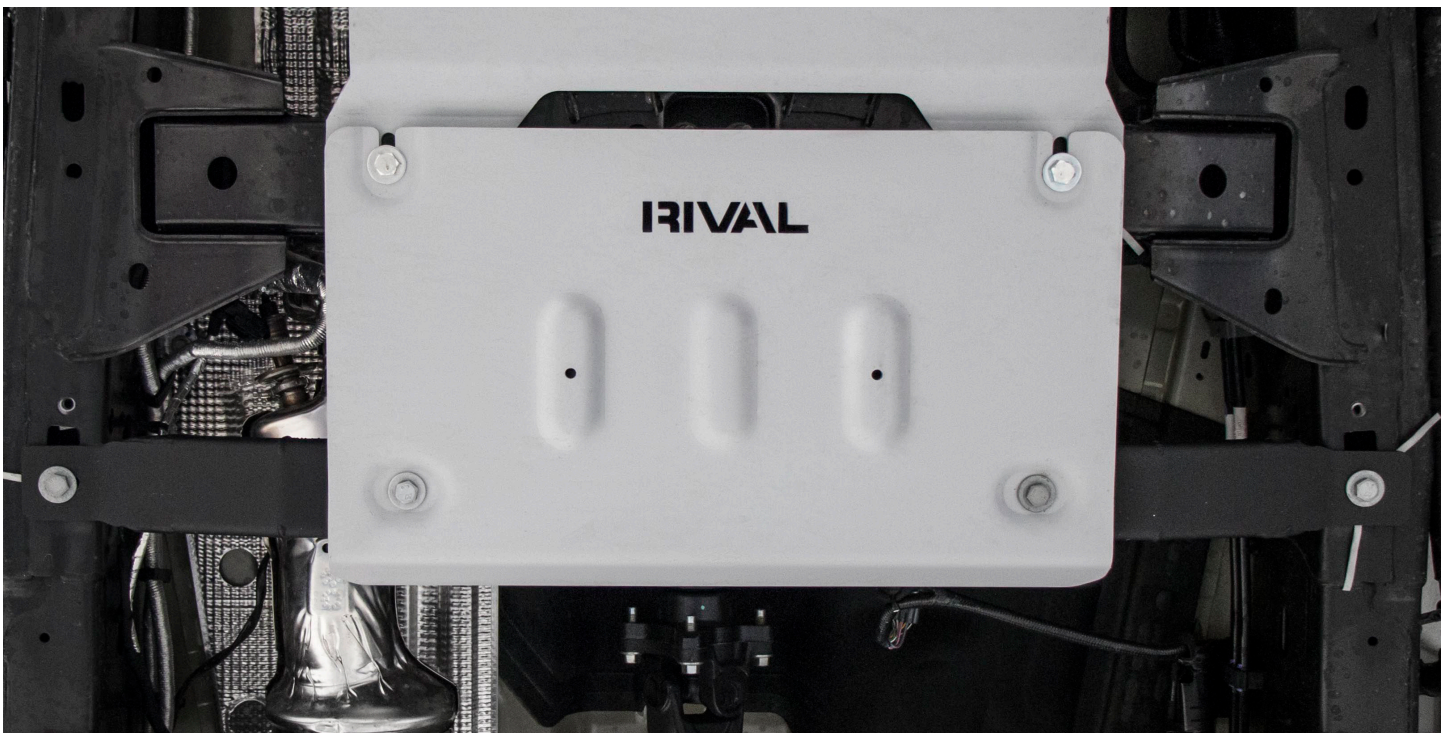

## CAUTION!

To reduce the risk of serious injury or damage to property: Before you start installing and using this product, read the full instructions, pay special attention to the conditions of safe use and recommendations for installation! When installing or maintaining this product, it is necessary to use protective goggles. Check the integrity of the structure and the moment the fastening is tightened every 250 miles (400 kms) of mileage. Do not use this product if there is damage to the structure or fasteners!

## NOTICE

Skid plate is an additional protection, but it can not guarantee to protect against all possible damage in collisions. When driving, be careful of objects and terrain that may damage sensitive parts of the vehicle.

# TRANSFER CASE SKID PLATE



Part number 2111.1887.2.3  
2333.1887.2  
2333.1887.2.6

Suited to vehicle: FORD RANGER\* 2.0D Bi-Turbo, 3.0D; AT; 4WD (2022-)  
FORD RANGER RAPTOR 3.0; AT; 4WD (2022-)  
FORD EVEREST 2.0D Bi-Turbo; AT; 4WD (2022-)  
VOLKSWAGEN AMAROK 2.0D, 3.0D; AT; 4WD (2023-)

Material: Steel / Aluminum

\*Applicable to Double Cab



## SAFETY NOTICE

- \* The RIVAL transfer case skid plate is designed to complement the use and design of the specified vehicle under conditions specified by the vehicle manufacturer.
- \* While driving the vehicle at any speed, collision with any other vehicle, animal or object must always be avoided.
- \* Following any collision with any other vehicle, animal or object, the RIVAL transfer case skid plate and the vehicle must be inspected by a specialized or suitably qualified vehicle repairer for possible damage to the components and assemblies in order to confirm suitability for further use of the vehicle.
- \* It is strongly recommended that you do not operate a vehicle with a damaged transfer case skid plate or its components. In the case of damage, please contact the nearest RIVAL dealer. Vehicle, or where the skid plate has been damaged, is extremely dangerous and must be avoided at all cost.

## INSTALLATION NOTICE

- \* The RIVAL transfer case skid plate must be mounted and affixed to the vehicle according to this installation manual.
- \* Personal safety during the installation process must be adhered to at all times.
- \* Do not install this skid plate on vehicle models other than those allowed in this manual.
- \* Estimated time for installation: 1 hour.

## REQUIRED TOOLS

- \* Basic tool kit
- \* Torque wrench

## TORQUE SETTING

- \* M10 - 47 H·m (34.7 lb/ft)

# PARTS LISTING

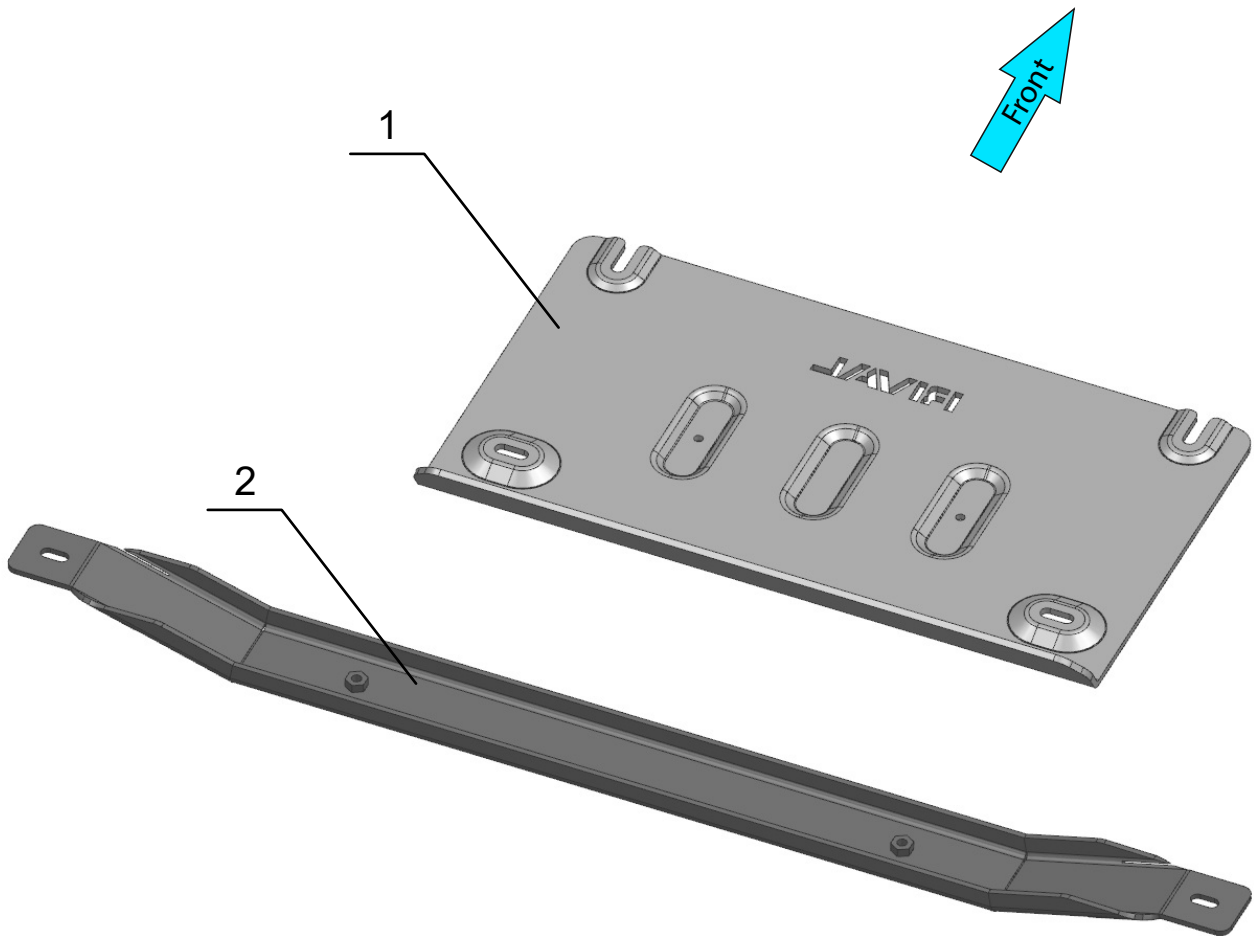

- 1. Transfer case skid plate.....Qty 1
- 2. Mount bracket.....Qty 1

# PARTS LISTING

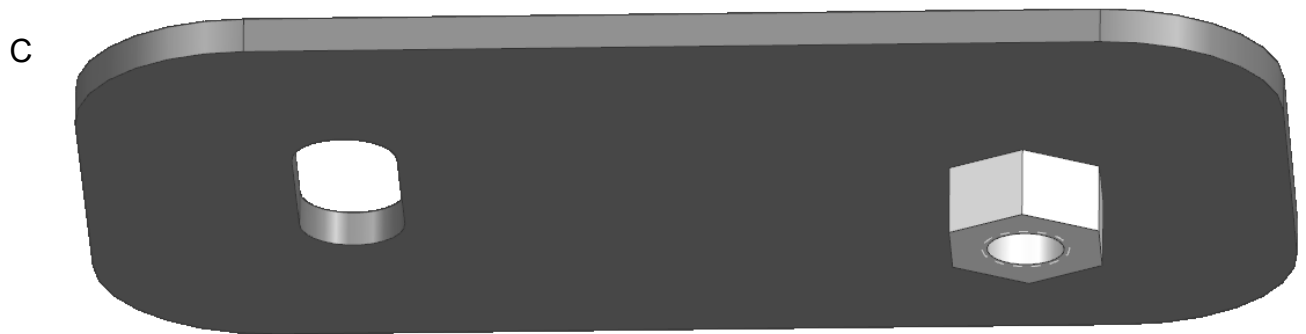
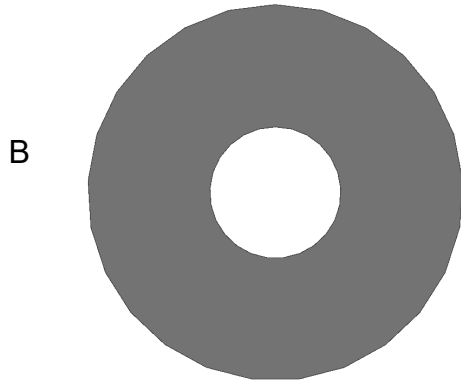
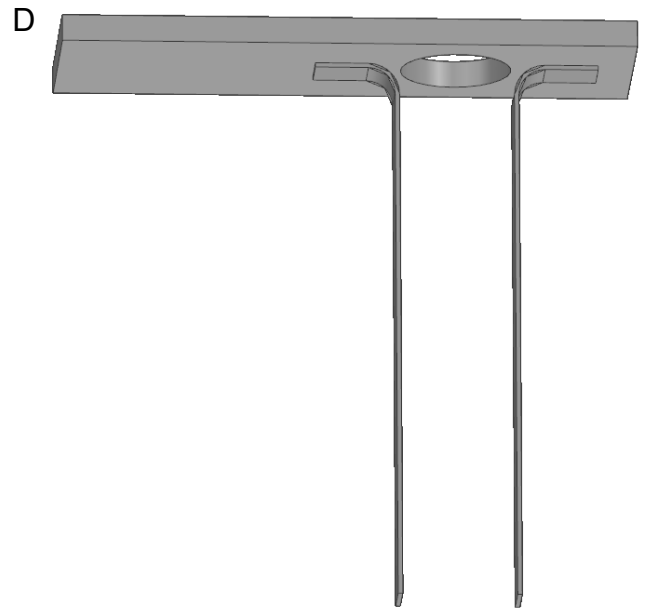
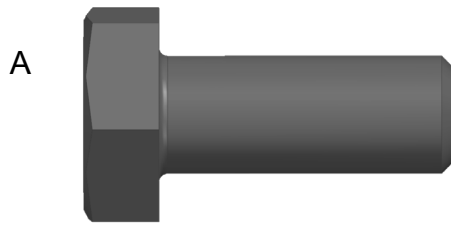

A. Bolt M10x30 (2 pc. preinstalled, as shipping hardware).....	Qty 8
B. Washer 10 (2 pc. preinstalled, as shipping hardware).....	Qty 8
C. Bracket.....	Qty 2
D. Insert nut M10.....	Qty 6

# INSTALLATION PROCEDURE



**\*If equipped, remove the factory skid plate or any other aftermarket skid plate.**

**\*Before installation: Unscrew bolts M10x30 (item A) and washers 10 (item B), preinstalled as shipping hardware, in mount bracket (item 2) and transfer case skid plate (item 1). Set aside to reuse later on.**

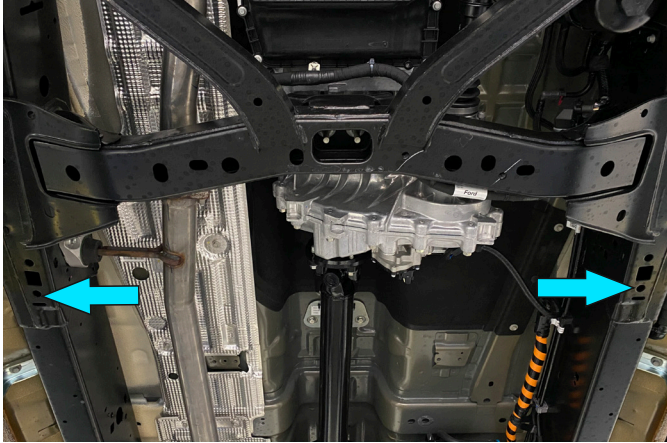

Fig. 1



Fig. 2

1. Install the insert nuts M10 (item D), as shown in fig.1 and fig.2.

**\*If equipped, use OE cage nuts.**

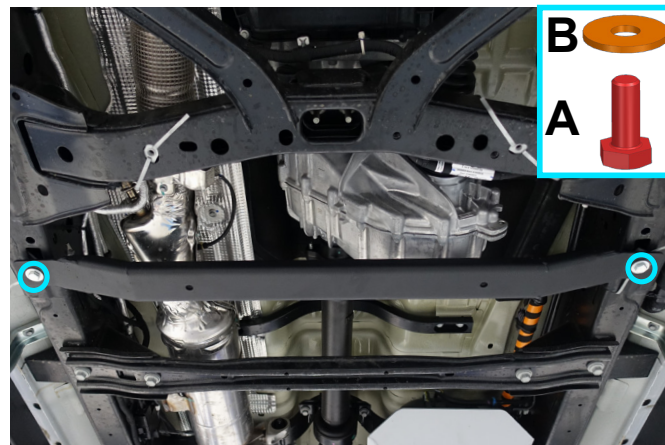

Fig. 3

2. Fix the mount bracket (item 2) to insert nuts M10 (item D) or OE cage nuts, using bolts M10x30 (item A) and washers 10 (item B) or OE fittings, as shown in fig.3.

**\*Do not tighten yet.**



Fig. 4

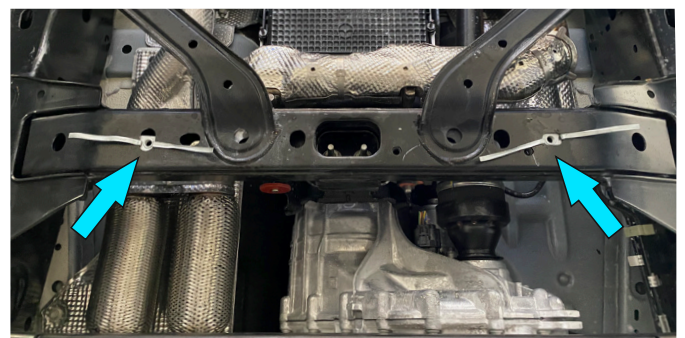

Fig. 5

3. Install the insert nut M10 (item D) or loosen rear bolts of RIVAL gearbox skid plate, as shown in fig.4 for Ranger, Everest, Amarok and fig.5 for Ranger Raptor.

## For FORD RANGER, FORD EVEREST and VOLKSWAGEN AMAROK

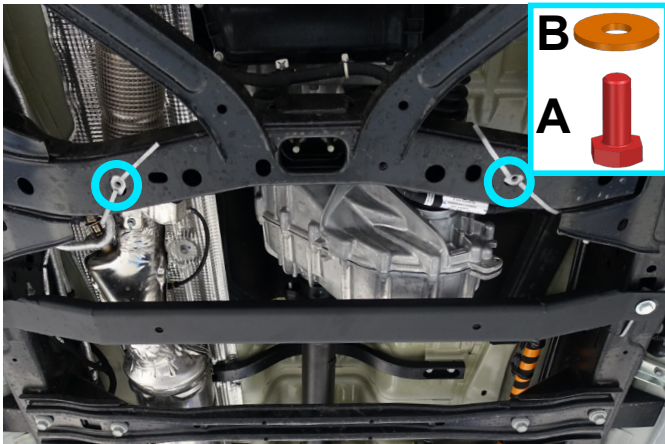

Fig. 6

4. Loosen bolts M10x30 (item A) and washers 10 (item B) in front mounting points (Fig.6).

**\*Do not tighten yet.**

**\*\*If you have RIVAL gearbox skid plate installed, skip this step.**

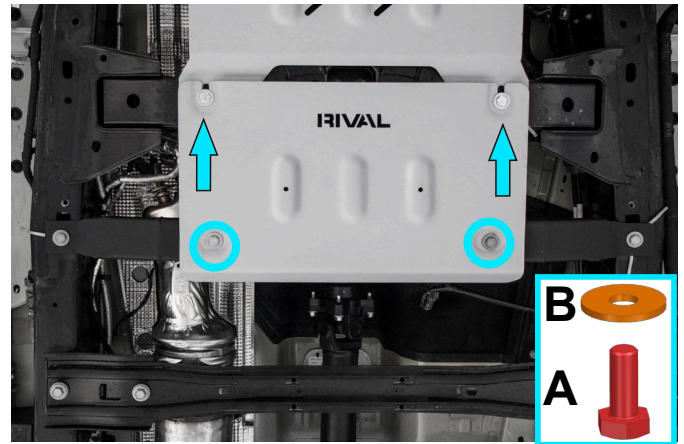

Fig. 7

5. Put transfer case skid plate (item 1) on installed bolts M10x30 and washers 10 from step 4. Fix the rear part of skid plate to mount bracket, using bolts M10x30 (item A) and washers 10 (item B), as shown in fig.7.

**\*Tighten hardware after that.**

## For FORD RANGER RAPTOR

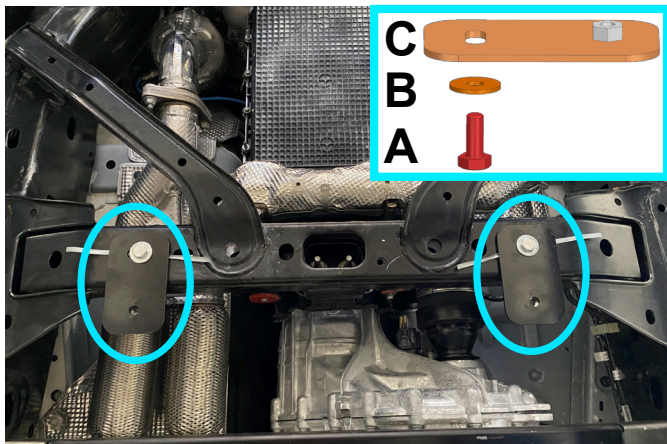

Fig. 8

6. Fix brackets (item C) to installed insert nut M10 (item D) from step 3, using bolts M10x30 (item A) and washers 10 (item B), as shown in fig.8.

**\*Do not tighten yet**

**\*\*If you have RIVAL gearbox skid plate installed, skip this step.**

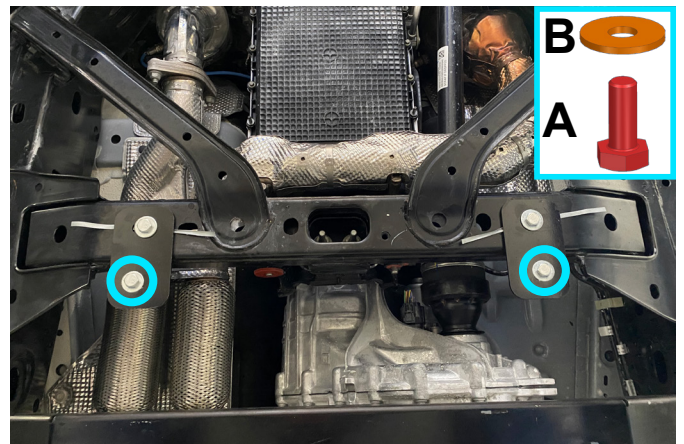

Fig. 9

7. Place bolts M10x30 (item A) and washers 10 (item B) to brackets (item C), as shown in fig.9.

**\*Do not tighten yet.**

**\*\*If you have RIVAL gearbox skid plate installed, skip this step.**

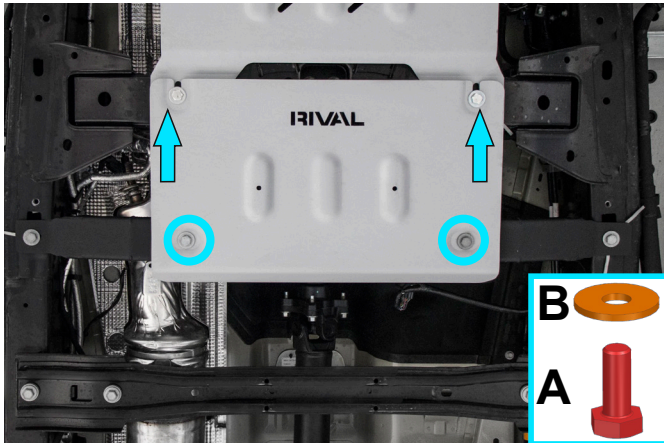

Fig. 10

8. Put transfer case skid plate (item 1) on installed bolts M10x30 and washers 10 from step 7. Fix the rear part of skid plate to mount bracket, using bolts M10x30 (item A) and washers 10 (item B), as shown in fig.10.  
**\*Tighten hardware after that.**

Before operating a vehicle fitted with RIVAL Skid Plate:

- make sure all fittings are tightened;
- ensure the integrity of the structure and its components.

