

Ford Ranger/Ranger Raptor/Everest Volkswagen Amarok



HOOD STRUT KIT Installation Instruction



Model year: Ford Ranger / Ranger Raptor/Everest - 2022-
Volkswagen Amarok - 2023-

Part No.: 2A.ST.5811.1

Compatibility: all types

Weight:  1.8 kg

Installation time:  30 min

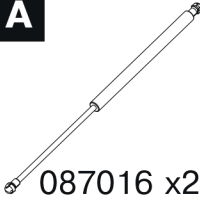
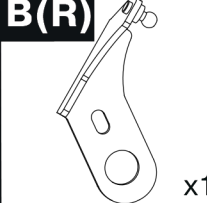
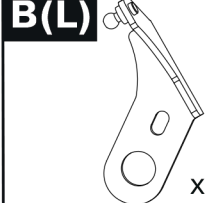
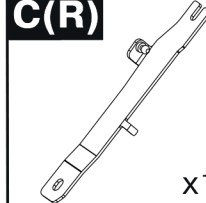
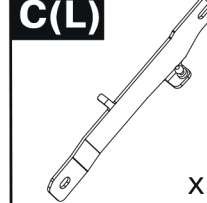
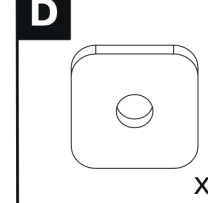
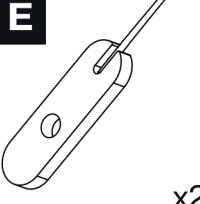
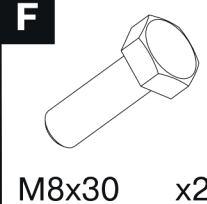
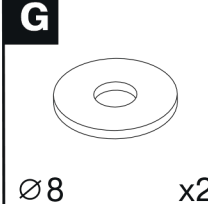
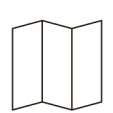
A  087016 x2	B(R)  x1	B(L)  x1	C(R)  x1	C(L)  x1	D  x2
E  x2	F  M8x30 x2	G  Ø8 x2	 Installation Instruction		

Required Tools

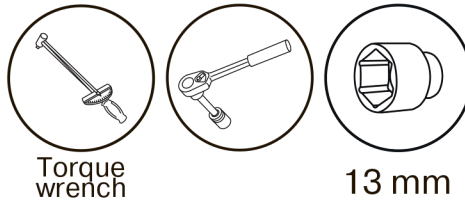

Before installation of gas struts, open the hood and check that there is no additional equipment installed in engine bay which can block installation.

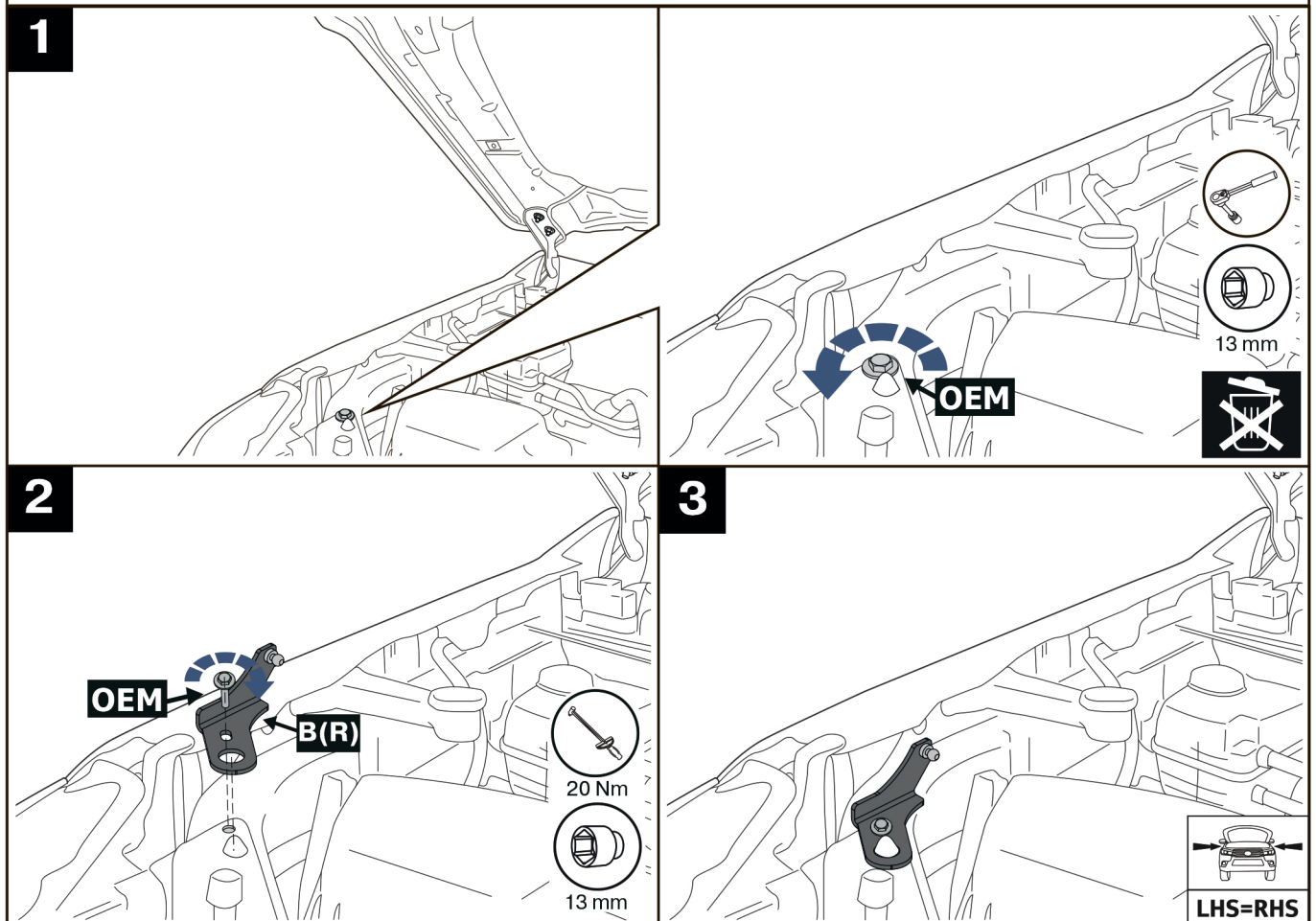

FORD RANGER/RANGER RAPTOR/EVEREST
VOLKSWAGEN AMAROK

HOOD STRUT KIT

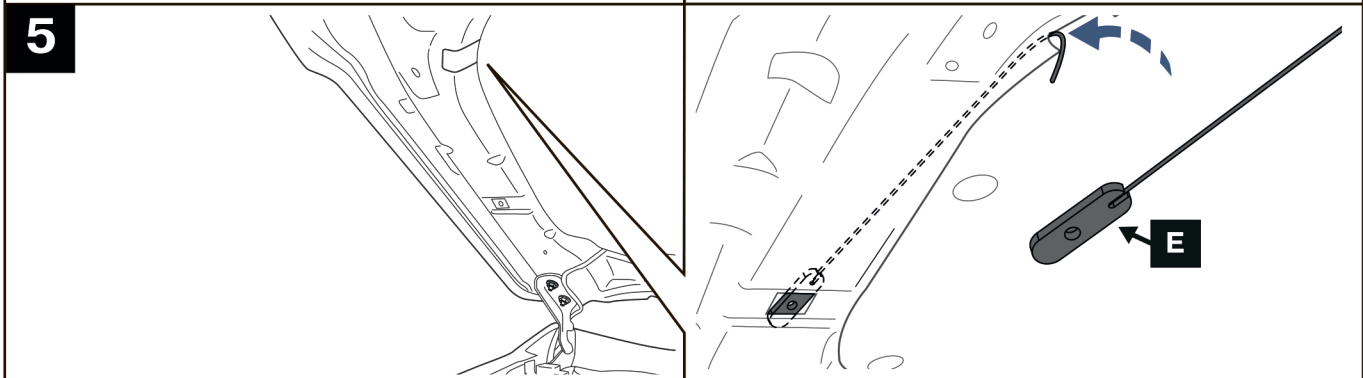
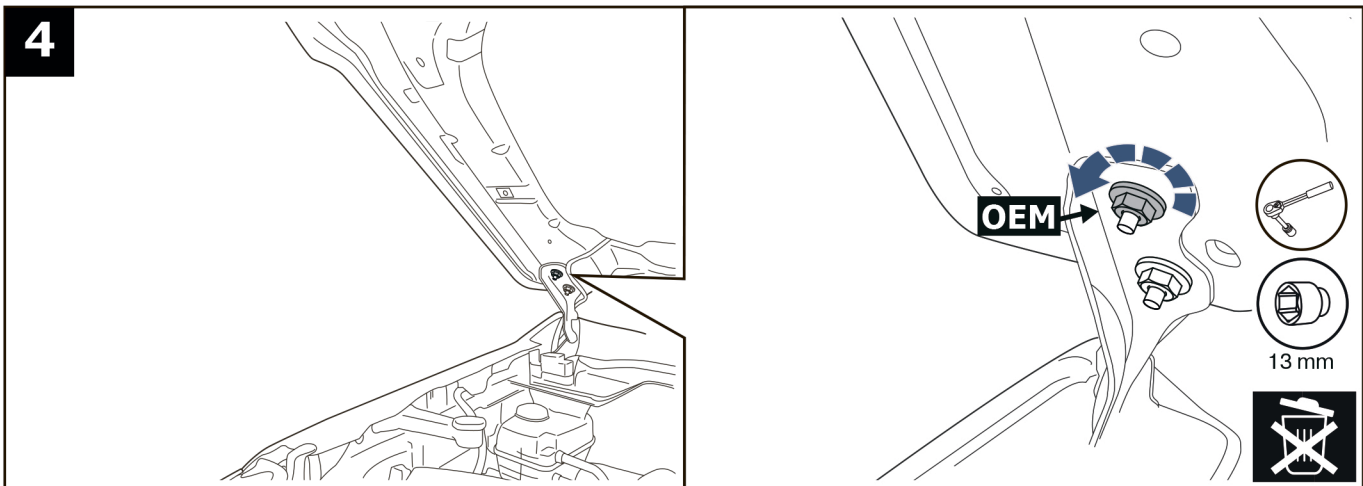

Step **6-9** only for Volkswagen Amarok

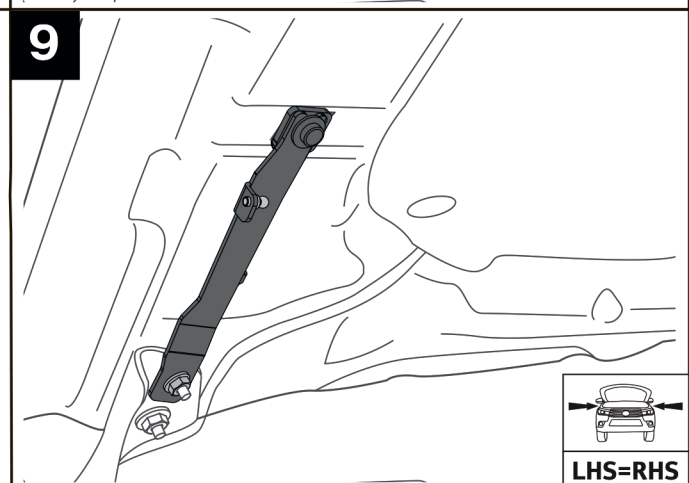
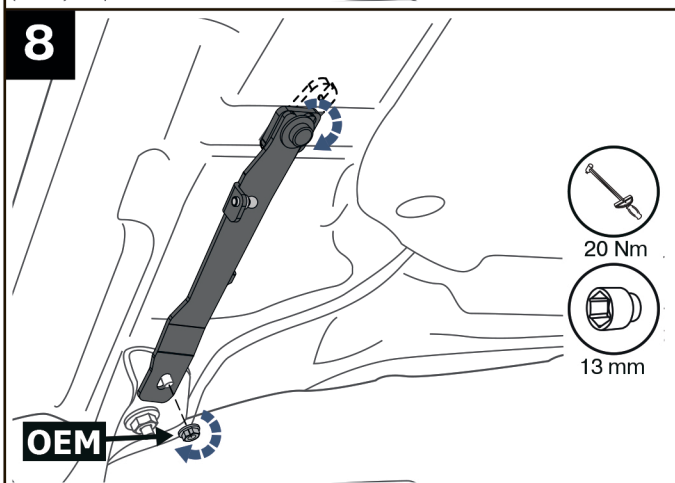
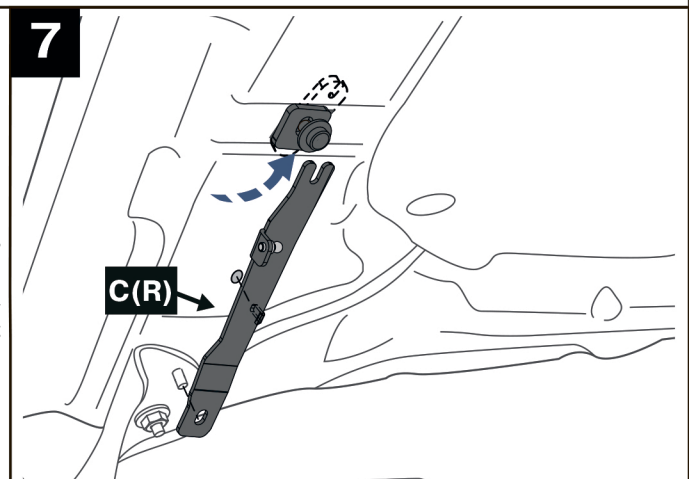
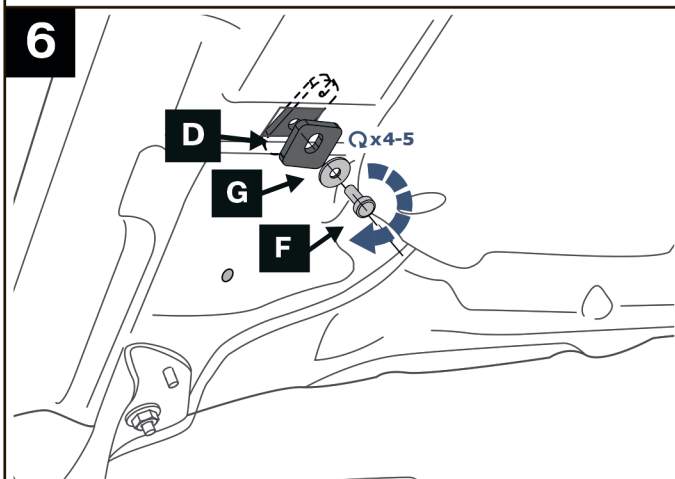

FORD RANGER/RANGER RAPTOR/EVEREST
VOLKSWAGEN AMAROK

HOOD STRUT KIT



Step **10-13** for other vehicles

10

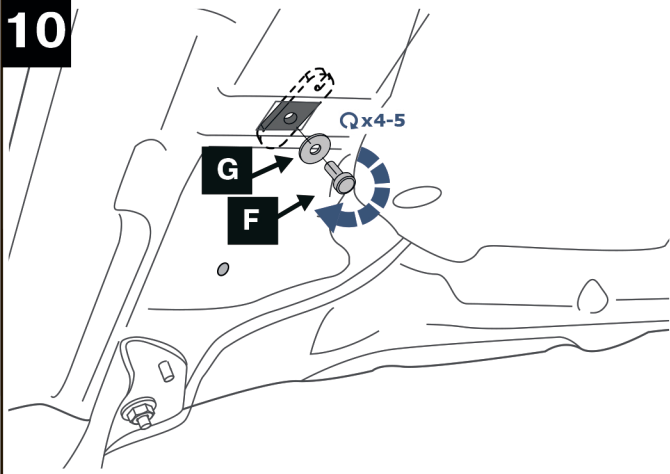

11

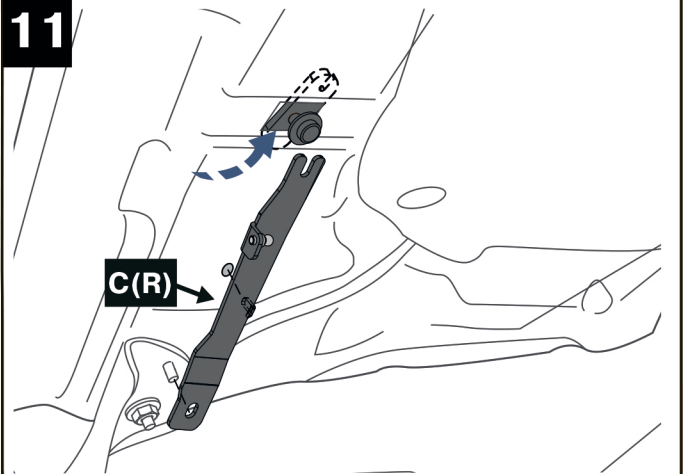

12

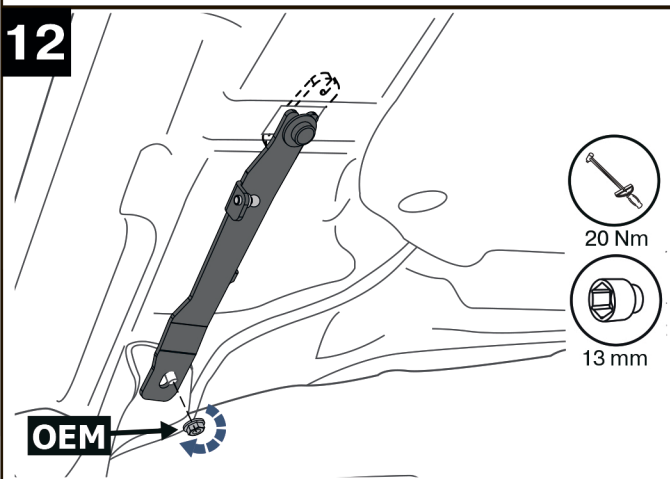

13

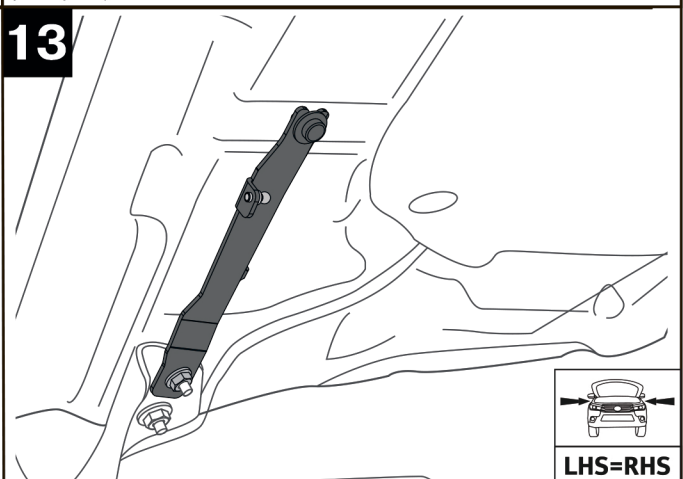

14

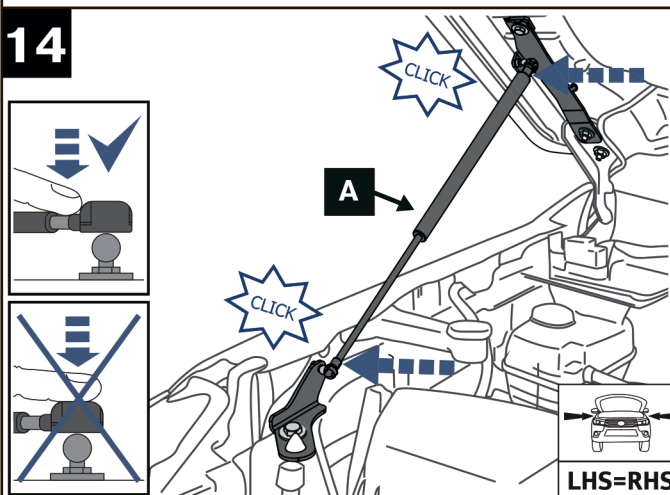

15

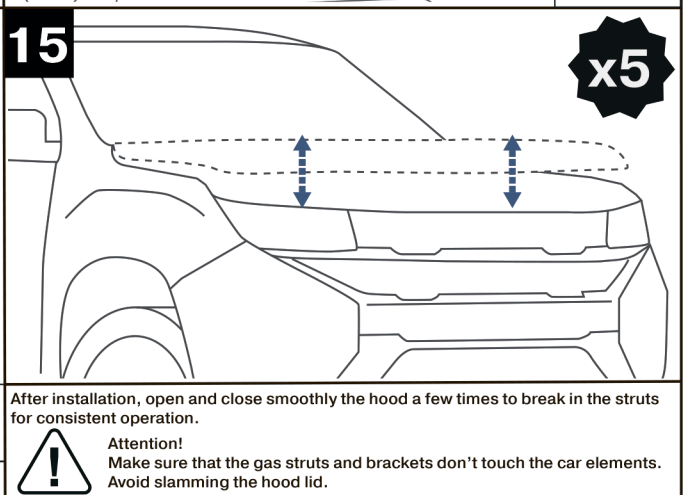

Attention!
Make sure that the gas struts and brackets don't touch the car elements.
Avoid slamming the hood lid.



Attention!
If it's needed to remove installed gas strut, disassemble how shown on the picture.
Operate with the hood being totally open.

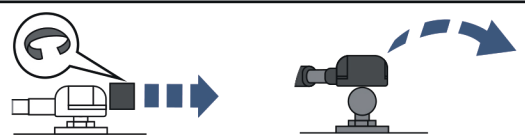

Check installation manual

After installation, check the correct operation of all elements.



FORD RANGER/RANGER RAPTOR/EVEREST
VOLKSWAGEN AMAROK

HOOD STRUT KIT